

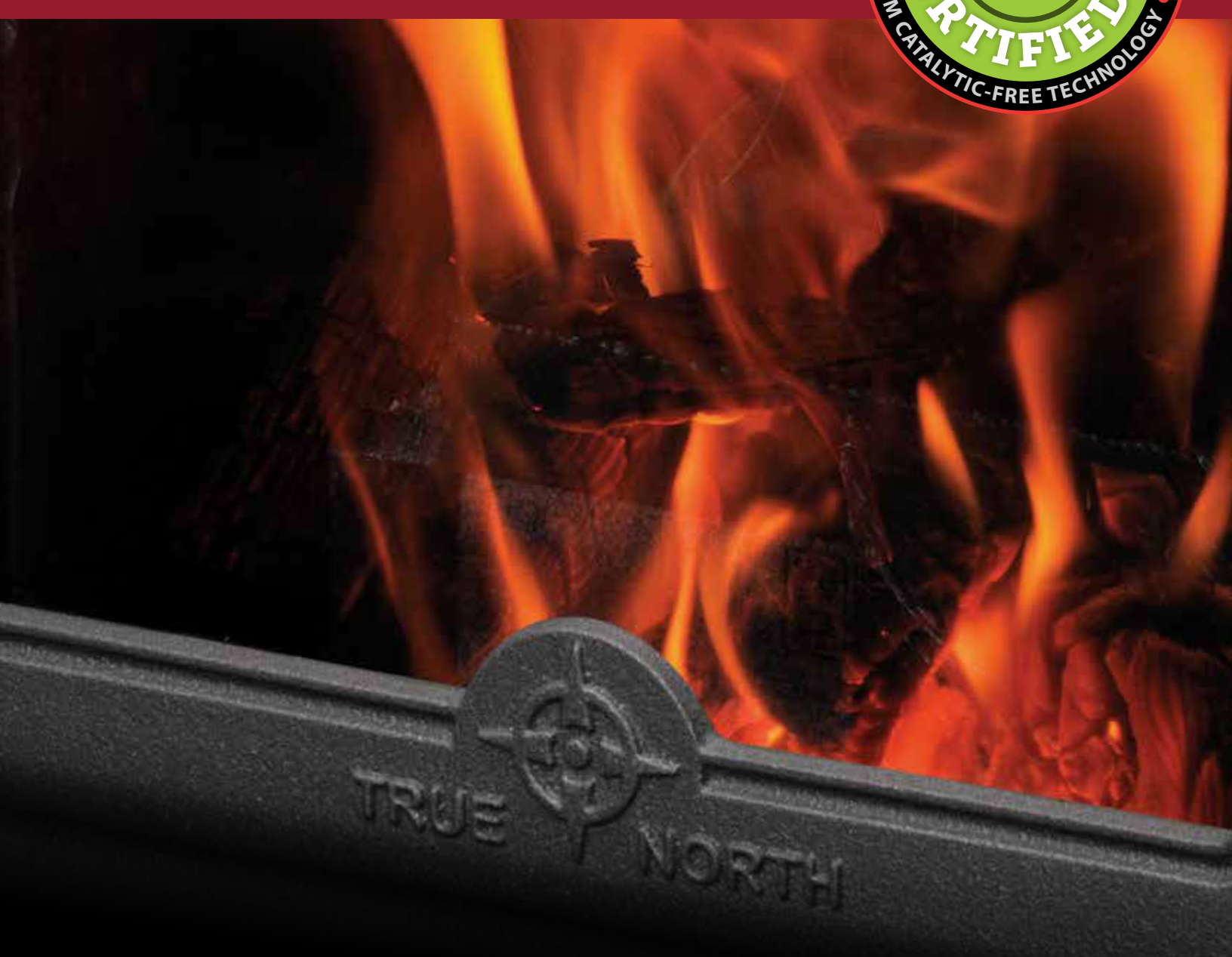

WOOD BURNING

STOVES AND INSERTS



TN10 | TN20 WOOD STOVE
TN20 WOOD INSERT

WOOD STOVES

True North Woodstoves offer an exceptional cost to performance ratio. Featuring entry-level tubes as part of the combustion system, the TN10 and TN20 are the cost effective solution for the price-minded wood burner. Each woodstove is constructed with quality 10-gauge steel, a gasketed cast iron door, clean glass airwash system, and engineered for high efficiency.



TN10 WOOD STOVE

Heat Output Cord Wood	30,000 BTU
Heat Output EPA (HHV)	13,100-17,600 BTU
Efficiency (B415)	73%
Emissions	1.4 g/hr.
Firebox Size	0.8 cu.ft.
Log Size (recommended/max.)	10 in. / 12 in.



TN20 WOOD STOVE SERIES B

Heat Output Cord Wood	55,000 BTU
Heat Output EPA (HHV)	13,900-29,200 BTU
Efficiency (B415)	73%
Emissions	1.6g/hr.
Firebox Size	2.0 cu.ft.
Log Size (recommended/max)	18 in. / 20 in.

STANDARD FEATURES

Reliable, durable catalytic-free technology
 Tube combustion system
 Air wash system for super clean glass
 Inside and outside combustion air capable
 Boost air
 Heavy plate-steel top

Mobile home approved
 Single-Lever Air Control
 EPA Certified
 Cast iron door
 Pre-assembled for quick and easy installation

DESIGN OPTIONS (TN20 only)
 Choice of leg model or pedestal model

PERFORMANCE OPTIONS
 80 cfm convection blower

WOOD INSERTS

Convert an existing fireplace into a source of efficient heat with the TN20 Wood Insert. This powerful 2.0 cubic firebox will heat small to medium spaces, burn clean and will offer years of trouble free warmth. The gasketed cast iron door seals the firebox to avoid unnecessary air loss, while clean air-wash technology ensures a full view of the fire while in use.



TN20 WOOD INSERT SERIES B

Heat Output Cord Wood	55,000 BTU
Heat Output EPA (HHV)	13,900-29,200 BTU
Efficiency (B415)	73%
Emissions	1.6g/hr.
Firebox Size	2.0 cu.ft.
Log Size (recommended/max)	18 in. / 20 in.

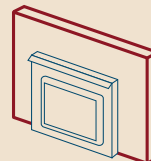

Standard Surround
38 x 27 x 2
(complete with unit)

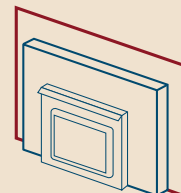

Oversize Backing Plate
48 x 32
(sold separately)

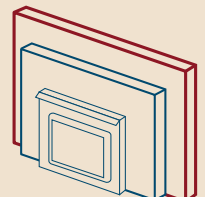

Oversize Deep Recess Extension
46 x 31 x 2
(sold separately)

STANDARD FEATURES

Reliable, durable catalytic-free technology
Tube combustion system
Air wash system for super clean glass
Inside and outside combustion air capable
Boost air Blower

Single-lever air control
EPA certified
Cast iron door
Complete with standard size surround
Pre-assembled for quick and easy installation

DESIGN OPTIONS

Oversize surround backing plate
2 deep recess oversize surround extension

FLOOR PROTECTOR AREA

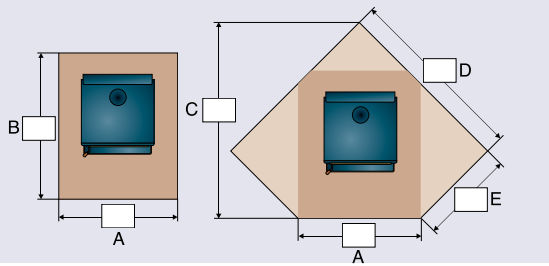

MINIMUM CLEARANCES TO COMBUSTIBLES

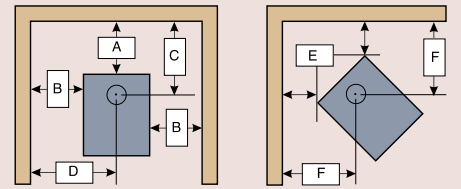

TN10 WOOD STOVE

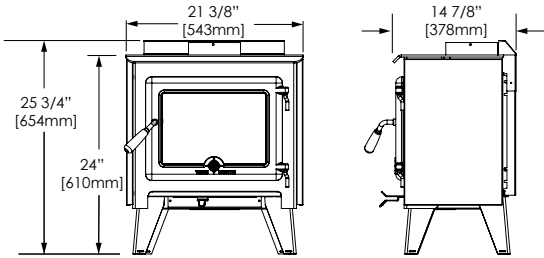

FLOOR PROTECTOR AREA

	CANADA					USA				
	A	B	C	D	E	A	B	C	D	E
Minimum (Not extended to back wall)	37 3/8	40	-	-	-	28 3/8	29 1/2	-	-	-
Residential, single wall, vertical connector	37 3/8	40	49 3/4	48 3/8	22	28 3/8	37 1/2	47 1/4	43 1/2	23 3/8
Residential, double wall, vertical connector	37 3/8	38	45 1/2	45 3/8	19	28 3/8	35 1/2	43	40 1/2	20 3/8
Alcove, double wall, connector	37 3/8	38	-	-	-	28 3/8	35 1/2	-	-	-
Mobile home	37 3/8	38	45 1/2	45 3/8	19	28 3/8	35 1/2	43	40 1/2	20 3/8

MINIMUM CLEARANCES TO COMBUSTIBLES

Minimum Clearance from top of Stove to Ceiling = 57.75 in.

	RESIDENTIAL					
	A	B	C	D	E	F
Single Wall Vertical or Horizontal Connector	8	8	13 1/4	18 5/8	6	16 1/4
Double Wall Vertical or Horizontal Connector	6	8	11 1/4	18 5/8	3	13 1/4

	MOBILE HOME					
	A	B	C	D	E	F
Double Wall Vertical Connector only	6	8	11 1/4	18 5/8	3	13 1/4

TN20 WOOD STOVE

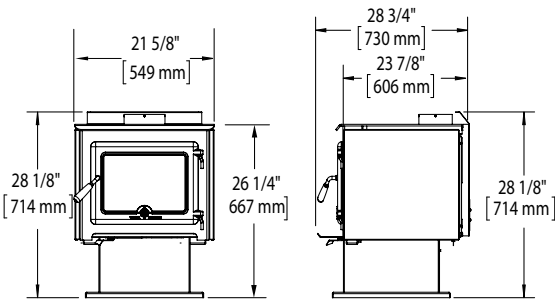

FLOOR PROTECTOR AREA

	CANADA					USA				
	A	B	C	D	E	A	B	C	D	E
Minimum (Not extended to back wall)	37 5/8	50	-	-	-	28 1/2	40	-	-	-
Residential, single wall, vertical connector	37 5/8	54	63 3/8	58 1/8	31 1/2	28 1/2	52	60 5/8	53	32 3/4
Residential, double wall, vertical connector	37 5/8	47	56 1/4	53 1/8	26 1/2	28 1/2	45	53 1/2	48	27 3/4
Alcove, double wall, connector	37 5/8	47	-	-	-	28 1/2	45	-	-	-
Mobile home	37 5/8	47	56 1/4	53	26 1/2	28 1/2	45	53 1/2	48	27 3/4

MINIMUM CLEARANCES TO COMBUSTIBLES

Minimum Clearance from top of Stove to Ceiling = 56.75 in.

	RESIDENTIAL					
	A	B	C	D	E	F
Single Wall Vertical or Horizontal Connector	12	12	18 3/8	22 5/8	8	19
Double Wall Vertical or Horizontal Connector	5	8	11 3/8	18 5/8	3	14

	MOBILE HOME					
	A	B	C	D	E	F
Double Wall Vertical Connector only	5	8	11 3/8	18 5/8	3	14

TN20 WOOD INSERT

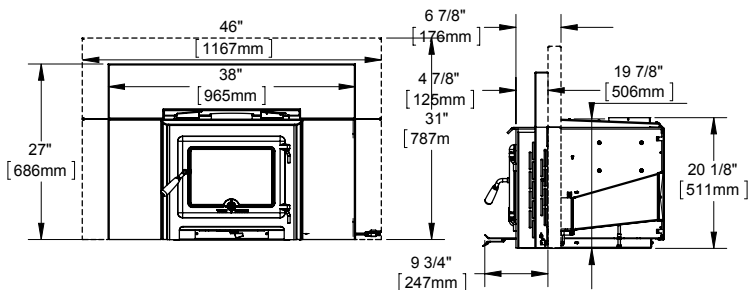

MINIMUM FIREPLACE OPENING (IN)

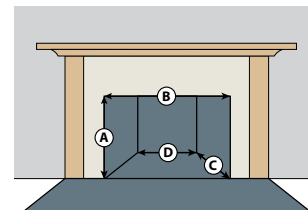

A	B	C	D
20.25	29	18	22

CLEARANCES TO COMBUSTIBLES (IN)

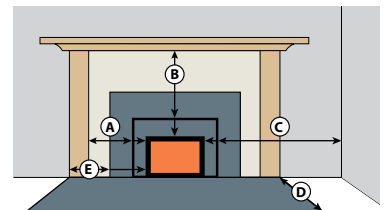

A	B	C	D	E
8.5	15	12	16 USA 18 Canada	8

* all products subject to change without warning Due to the limitations of the printing process, it is not possible to replicate colours exactly in a print format. Please check with your local Pacific Energy retailer for colour samples.