

INSTALLATION INSTRUCTIONS

INSTALLER:

Leave this manual with the appliance.

CONSUMER:

Retain this manual for future reference.

WARNING: If the information in these instructions is not followed exactly a fire or explosion may result causing property damage, personal injury or death.

FOR YOUR SAFETY

Do not store or use gasoline or other flammable vapours and liquids in the vicinity of this or any other appliance.

WHAT TO DO IF YOU SMELL GAS

- Do not try to light any appliance.
- Do not touch any electrical Switch.
- Do not use any phone in your building.
- Immediately call your gas supplier from a neighbour's phone. Follow the gas supplier's instructions.
- If you cannot reach your gas supplier call the fire department.

Installation and service must be performed by a qualified installer, service agency or the gas supplier.

This appliance may be installed in an after-market permanently located, manufactured home (USA only) or mobile home, where not prohibited by local codes.

This appliance is only for use with the type of gas indicated on the rating plate. This appliance is not convertible for use with other gases unless a certified kit is used.

This appliance is suitable for installation in a bedroom or bed sitting room.



TOFINO INSTALLATION INSTRUCTIONS



MODEL: TOFINO i20
(SIT & Maxitrol G6R versions)

SERIES: A

DIRECT VENT GAS INSERT



Visit www.pacificenergy.net for the most recent version of this manual

Table Of Contents

<p>Important Note for the Commonwealth of Massachusetts 3</p> <p>Caution 4</p> <p>Safety 5</p> <p>WHAT TO DO IF YOU SMELL GAS 5</p> <p>First Fire 6</p> <p>Warnings and Cautions 6</p> <p>Fireplace Dimensions 7</p> <p>Tofino Insert Backing Plate Dimensions 8</p> <p>Existing Fireplace Preparation 9</p> <p>Clearances to Combustibles 10</p> <p style="padding-left: 20px;">Horizontal Clearances..... 10</p> <p style="padding-left: 20px;">Objects in front of Appliance 10</p> <p style="padding-left: 20px;">Mantel Clearances 10</p> <p style="padding-left: 20px;">Mantel Depth 10</p> <p style="padding-left: 20px;">Hearth Clearance 10</p> <p style="padding-left: 20px;">Under Appliance 10</p> <p>Adjustable Leveling Bolts 11</p> <p>Removable Handles 11</p> <p>Venting 12</p> <p style="padding-left: 20px;">Flue adapter 13</p> <p>SIT Control Overview 14</p> <p>Maxitrol Control Overview 14</p> <p>Door Installation/Removal 15</p> <p style="padding-left: 20px;">Removal 15</p> <p style="padding-left: 20px;">Installation 15</p> <p>Panel Installation 16</p> <p>Baffle 18</p> <p style="padding-left: 20px;">Cleaning the ceramic glass baffle: 18</p> <p style="padding-left: 20px;">Installing the ceramic baffle: 18</p> <p>Electrical Supply 19</p> <p>Gas Supply 19</p> <p>Gas Valve for SIT Configuration 20</p> <p style="padding-left: 20px;">SIT controller..... 20</p> <p style="padding-left: 20px;">SIT gas valve..... 20</p>	<p>Gas valve for Maxitrol Configuration21</p> <p style="padding-left: 20px;">Maxitrol controller21</p> <p style="padding-left: 20px;">Maxitrol gas valve21</p> <p>Gas Pressure Check / Output / Efficiency 22</p> <p>Gas Pressure Testing Procedure 23</p> <p>Damper Adjustment 24</p> <p style="padding-left: 20px;">Damper Adjustment: 24</p> <p>Venturi Adjustment 25</p> <p>Glass Media Installation 26</p> <p>Split Log Set Installation27</p> <p style="padding-left: 20px;">Log set Installation 28</p> <p>Driftwood Log Set Installation 33</p> <p style="padding-left: 20px;">Log set Installation 33</p> <p>Manual Switch Installation for SIT Units 39</p> <p style="padding-left: 20px;">To install ON/OFF Switch 39</p> <p>Manual Switch Installation for Maxitrol Units41</p> <p style="padding-left: 20px;">To install ON/OFF Switch41</p> <p>Pairing the SIT Remote Handset and Receiver 43</p> <p>Pairing the Maxitrol Remote Handset and Receiver 44</p> <p>Surround Installation/Removal Instructions 45</p> <p style="padding-left: 20px;">Installation 45</p> <p style="padding-left: 20px;">Removal 45</p> <p>Lighting Instructions 46</p> <p>Maintenance47</p> <p style="padding-left: 20px;">Glass Door47</p> <p style="padding-left: 20px;">Periodically:.....47</p> <p>Wiring Diagram for SIT Proflame 48</p> <p>Wiring Diagram for Maxitrol 49</p> <p>Tofino i20 Rating Label 50</p> <p style="padding-left: 20px;">Rating label location51</p>
-----------------------------------------------------------------------------------------------------------------------------------------------------------------------------------------------------------------------------------------------------------------------------------------------------------------------------------------------------------------------------------------------------------------------------------------------------------------------------------------------------------------------------------------------------------------------------------------------------------------------------------------------------------------------------------------------------------------------------------------------------------------------------------------------------------------------------------------------------------------------------------------------------------------------------------------------------------------------------------------------------------------------------------------------------------------------------------------------------------------------------------------------------------------------------------------------------------------------------------------------------------------------------------------------------------------------------------------------------------------------------------------------------------------------------------------------------------------------------------------------------------------------------------------------------------------------------------------------------------------------------------------------------------------	----------------------------------------------------------------------------------------------------------------------------------------------------------------------------------------------------------------------------------------------------------------------------------------------------------------------------------------------------------------------------------------------------------------------------------------------------------------------------------------------------------------------------------------------------------------------------------------------------------------------------------------------------------------------------------------------------------------------------------------------------------------------------------------------------------------------------------------------------------------------------------------------------------------------------------------------------------------------------------------------------------------------------------------------------------------------------------------------------------------------------------------------------------------------------------------------------------------------------------------------------------------------------------------------------------------------------------------------------------------------------------------------------------------------------------------------------------------------------------------------------------------------------------------------------------------------------------------------------------------------------------------------------------

**NATIONAL
FIREPLACE
INSTITUTE**



CERTIFIED

www.nficertified.org

We recommend that our gas hearth products be installed and serviced by professionals who are certified in the U.S. by the National Fireplace Institute® (NFI) as NFI Gas Specialists.

Important Note for the Commonwealth of Massachusetts:

From Massachusetts Rules and Regulations 248 5.08:

- (a) For all side wall horizontally vented gas fueled equipment installed in every dwelling, building or structure used in whole or in part for residential purposes, including those owned or operated by the Commonwealth and where the side wall exhaust vent termination is less than seven (7) feet above finished grade in the area of the venting, including but not limited to decks and porches, the following requirements shall be satisfied.
1. **INSTALLATION OF CARBON MONOXIDE DETECTORS.** At the time of installation of the side wall horizontal vented gas fueled equipment, the installing plumber or gas fitter shall observe that a hard wired carbon monoxide detector with an alarm and battery back-up is installed on the floor level where the gas equipment is to be installed, in addition, the installing plumber or gas fitter shall observe that a battery operated or hard-wired carbon monoxide detector with an alarm is installed on each additional level of the dwelling, building or structure served by the side wall horizontal vented gas fueled equipment. It shall be the responsibility of the property owner to secure the services of qualified licensed professionals for the installation of hard-wired carbon monoxide detectors.
 - a. In the event that the side wall horizontally vented gas fueled equipment is installed in a crawl space or an attic, the hard-wired carbon monoxide detector with alarm and battery back-up may be installed on the next adjacent floor level.
 - b. In the event that the requirements of this subdivision cannot be met at the time of completion of installation, the owner shall have a period of thirty (30) days to comply with the above requirements; provided, however, that during said thirty (30) day period, a battery operated carbon monoxide detector with an alarm shall be installed.
 2. **APPROVED CARBON MONOXIDE DETECTORS.** Each carbon monoxide detector as required in accordance with the above provisions shall comply with NFPA 720 and be ANSI/UL 2034 listed as IAS certified.
 3. **SIGNAGE.** A metal or plastic identification plate shall be permanently mounted to the exterior of the building at a minimum height of eight (8) feet above grade directly in line with the exhaust vent terminal for the horizontally vented gas fueled heating appliance or equipment. The sign shall read, in print size no less than one-half (1/2) inch in size, "GAS VENT DIRECTLY BELOW. KEEP CLEAR OF ALL OBSTRUCTIONS".
 4. **INSPECTION.** The state or local gas inspector of the side wall horizontally vented gas fueled equipment shall not approve the installation unless, upon inspection, the inspector observes carbon monoxide detectors and signage installed in accordance with the provisions of 248 CMR 5.089(2) (a) 1 through 4.
- (b) **EXEMPTIONS.** The following equipment is exempt from 248 CMR 5.089(2)(a) 1 through 4.
1. The equipment listed in Chapter 10 entitled "Equipment Not Required To Be Vented" in the most current edition of NFPA 54 as adopted by the Board; and
 2. Product Approved side wall horizontal vented gas fueled equipment installed in a room or structure separate from the dwelling, building or structure used in whole or in part for residential purposes.
- (c) **MANUFACTURER REQUIREMENTS – GAS EQUIPMENT VENTING SYSTEM PROVIDED.** When the manufacturer of Product Approved side wall horizontally vented gas equipment provides a venting system design or venting system components with the equipment, the instructions provided by the manufacturer for installation of the equipment and the venting system shall include:
1. Detailed instructions for the installation of the venting system design or the venting system components; and
 2. A complete parts list for the venting system design or venting system.
- (d) **MANUFACTURER REQUIREMENTS – GAS EQUIPMENT VENTING SYSTEM NOT PROVIDED.** When the manufacturer of a Product Approved side wall horizontally vented gas fueled equipment does not provide the parts for venting the fuel gases, but identifies "special venting systems", the following requirements shall be satisfied by the manufacturer.
1. The referenced "special venting system" instructions shall be included with the appliance or equipment installation instructions; and
 2. The "special venting systems" shall be Product Approved by the Board, and the instructions for that system shall include a parts list and detailed installation instructions.
- (e) A copy of all installation instructions for all Product Approved side wall horizontally vented gas fueled equipment, all venting instructions, all parts lists for venting instructions, and/or all venting design instructions shall remain with the appliance or equipment at the completion of the installation.

Caution

FOR YOUR SAFETY - Do not install or operate your Pacific Energy fireplace without first reading and understanding this manual. Any installation or operational deviation from the following instructions voids the Pacific Energy Fireplace Warranty and may prove hazardous.

This appliance and its individual shut off valve must be disconnected from gas supply piping system during any pressure testing of that system at test pressures in excess of 1/2 psig (3.5 kPa).

This appliance must be isolated from the gas supply piping system by closing its individual manual shut off valve during any pressure testing of the gas supply piping system at test pressures equal to or less than 1/2 psig (3.5 kPa).

Note: When lit for the first time, the appliance will emit a slight odour for a couple of hours. This is due to the curing of paints, sealants and lubricants used in the manufacturing process. This condition is temporary. Open doors and windows to ventilate area. Smoke and fumes caused by the curing process may cause discomfort to some individuals.

Do not use the fireplace if any part has been under water. Immediately call a qualified service technician to inspect the fireplace and to replace any part of the control system and any gas control which has been under water.

This fireplace is equipped with a micro mesh safety screen for your protection and must be installed with the unit. Removal of the safety screen will cause the fireplace to become a burn hazard.



DANGER



**HOT GLASS WILL CAUSE
BURNS.**

**DO NOT TOUCH GLASS UNTIL
COOLED.**

**NEVER ALLOW CHILDREN TO
TOUCH GLASS.**

A barrier designed to reduce the risk of burns from the hot viewing glass is provided with the appliance and shall be installed for the protection of children and other at-risk individuals.

Safety

- Due to high temperatures, this gas appliance should be located out of traffic and away from furniture and draperies.
- Children and adults should be alerted to the hazards of high surface temperatures and should stay away to avoid burns or clothing ignition.
- Young children should be carefully supervised when they are in the same room as the appliance. Toddlers, young children and others may be susceptible to accidental contact burns. A physical barrier is recommended if there are at risk individuals in the house. To restrict access to a fireplace or stove, install an adjustable safety gate to keep toddlers, young children and other at risk individuals out of the room and away from hot surfaces.
- Clothing or other flammable material should not be placed on or near the appliance.
- A barrier designed to reduce the risk of burns from the hot viewing glass is provided with the Surround Kit component and shall be installed.
- If the barrier becomes damaged, the barrier shall be replaced with the manufacturers barrier for this appliance.
- Any grill, panel or door removed for servicing the unit must be replaced prior to operating.
- Installation and repair should be done by a qualified service person. The appliance should be inspected before use and at least annually by a professional service person. More frequent cleaning may be required due to excessive lint from carpeting, bedding material, etc. It is imperative that control compartments, burners and circulating air passageways of the appliance be kept clean.
- This appliance must not be connected to a chimney flue serving a separate solid fuel burning appliance.
- It is our policy that no responsibility is assumed by the Company or by any of its employees or representatives for any damages caused by an inoperable, inadequate, or unsafe condition which is the result, either directly or indirectly, of any improper operation or installation procedures.

WHAT TO DO IF YOU SMELL GAS

- Do not try to light any appliance.
- Do not touch any electrical Switch.
- Do not use any phone in your building.
- Immediately call your gas supplier from a neighbor's phone. Follow the gas supplier's instructions.
- If you cannot reach your gas supplier call the fire department.
- Installation and service must be performed by a qualified installer, service agency or the gas supplier.

First Fire

When lit for the first time, the fireplace will emit a slight odour for a couple of hours. This is due to the curing of paints, sealants and lubricants used in the manufacturing process. This condition is temporary. Open doors and windows to ventilate area. Odour caused by the curing process may cause discomfort to some individuals.

It is normal for fireplaces fabricated of steel to give off some expansion and/or contraction noises during the start up or cool down cycle. Similar noises are found with your furnace heat exchanger or cook stove oven.

NOTE: Fireplace may take up to 30 seconds to ignite each time the "ON" button has been selected

Warnings and Cautions

WARNING

Fire Hazard. Can cause severe injury or death

The Receiver causes ignition of the appliance. The appliance can turn on suddenly. Keep away from the appliance burner when operating the remote system or activating manual bypass of the remote system.

WARNING

Shock Hazard. Can cause severe injury or death

This device is powered by line voltage. Do not try to repair this device. In no way is the enclosure to be tampered with or opened. Disconnect from line voltage before performing any maintenance.

Fireplace Dimensions

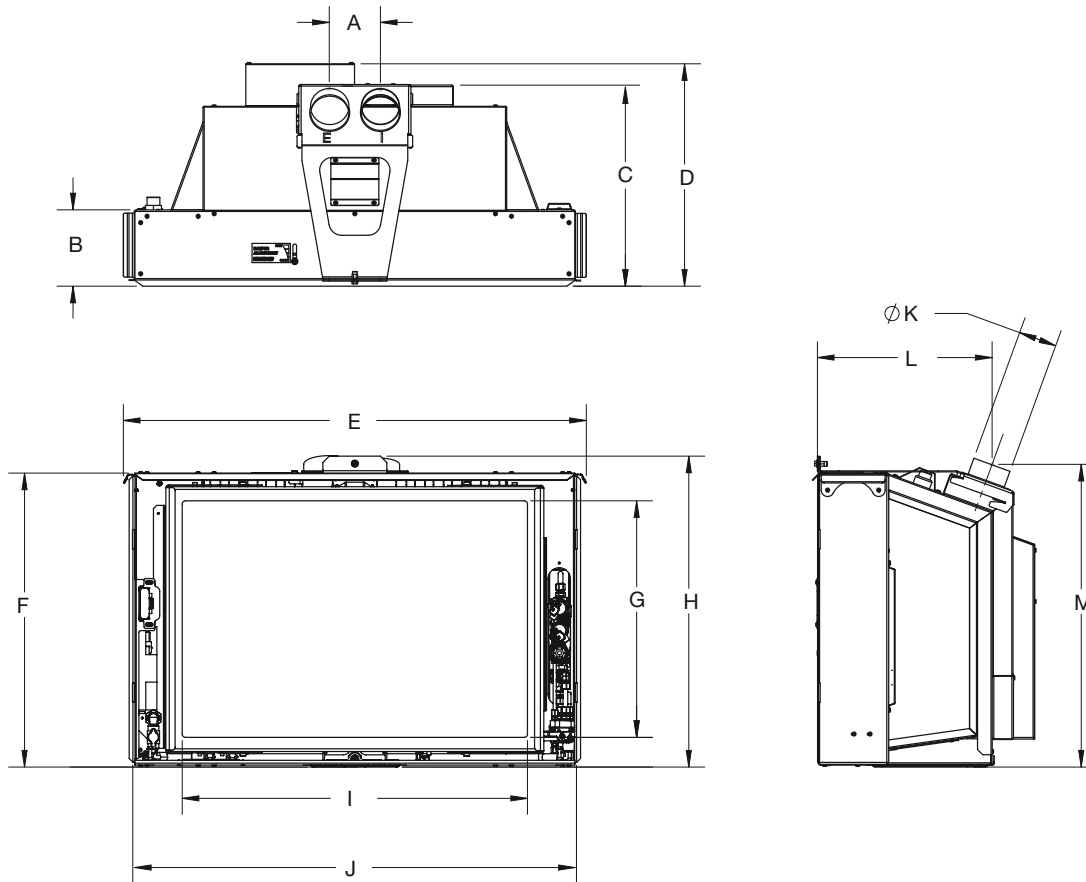

Figure 1: Tofino Dimensions.

	Tofino i20 SIT	Tofino i20 Maxitrol
A	4"	4"
B	6"	6"
C	15 5/8"	14 3/4"
D	17 3/8"	Use dimension "C"
E	30 1/4"	30 1/4"
F	18"	18"
G	13 1/4"	13 1/2"
H	19 3/8"	19 3/8"
I	21"	21"
J	28 1/2	28 1/2
K	3"	3"
L	13 5/8"	13 5/8"
M	18 5/8"	18 5/8"

Tofino Insert Backing Plate Dimensions

Tofino i20

HEIGHT / WIDTH	A	B
REGULAR	26"	38"
OVERSIZED	28"	42"
4-SIDED FULL FRAME	27 1/8"	35 1/4"

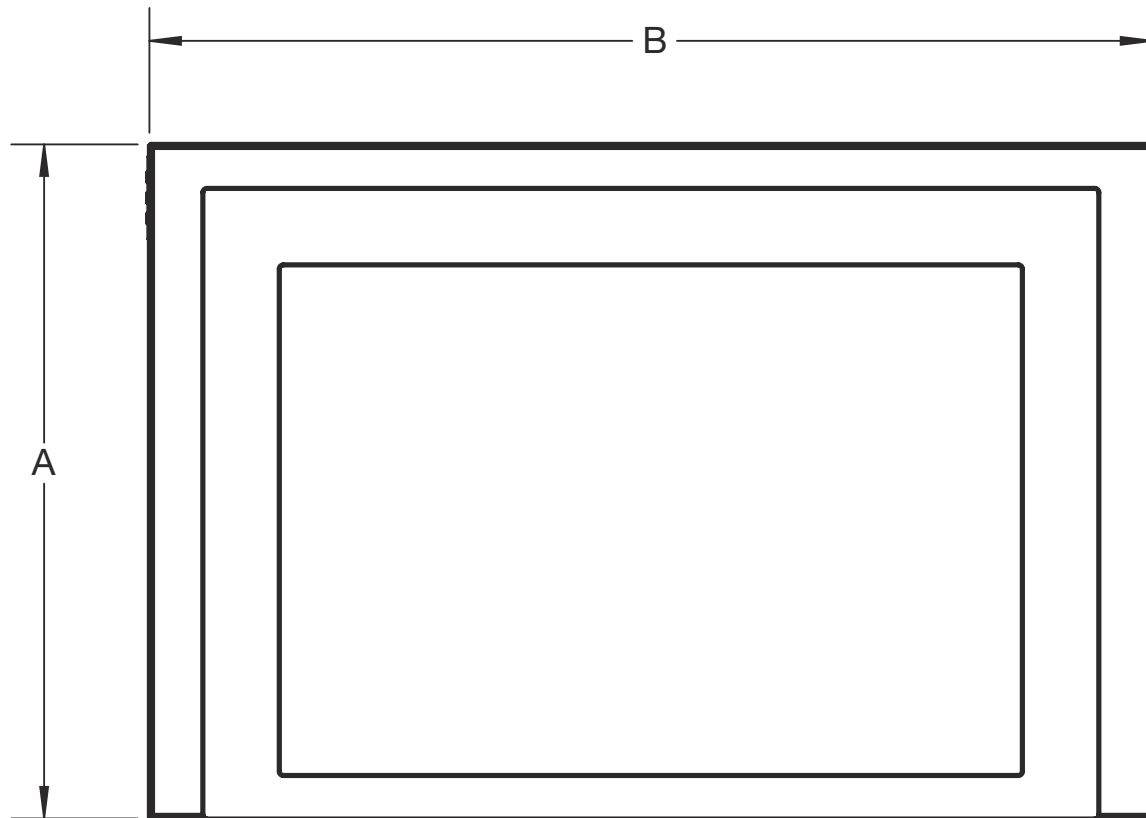

Figure 2: Tofino Surround dimensions.

Existing Fireplace Preparation

Note: SIT controlled installations require that an electrical outlet be installed either into an existing fireplace cavity before the Tofino is installed, or alternatively, the power cord can access a pre-existing power outlet elsewhere in the room by way of knock-out openings located on either side of the backing plate. See “Figure 35” on page 19.

The Tofino Gas inserts are certified to be installed into pre-existing approved fireplace. The minimum existing opening fireplace requirements are listed in Figure 3 below.

Dimension	i20 SIT	i20 Maxitrol
A	17 7/8”	16 1/4”
B	19 7/8”	19 7/8”
C without handles	29”	29”
C with handles	30 1/2”	30 1/2”

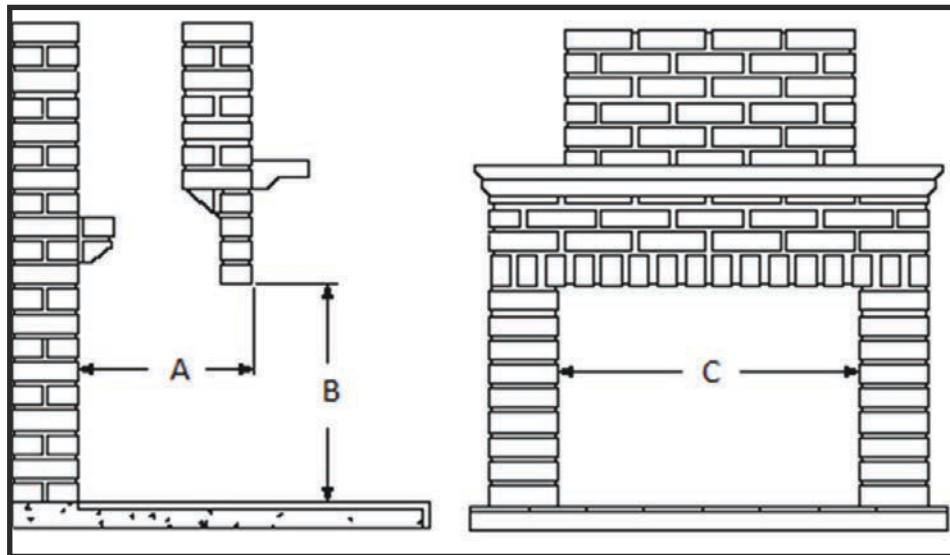

Figure 3: Minimum openings.

Before installing the Tofino inserts, have the chimney and fireplace swept including ash dumps and clean outs. Clean and remove any creosote and soot residue that may cause odors and stains after the insert has been installed. The fireplace chimney should be in good working order and made of non-combustible material. Make sure chimney clean-outs fit properly.

When preparing an existing fireplace to install a gas insert, any modifications that will compromise the integrity of the existing fireplace are not allowed. To make way for the inserts’ venting, the fireplace flue dampener may be blocked open or removed. Refractory, glass doors, screen rails, screen mesh and log grates can be removed from the fireplace before installing the insert. Also, smoke shelves, shields and baffles may be removed if attached by mechanical fasteners. Cutting any sheet metal parts of the fireplace, in which the gas fireplace insert is to be installed, is prohibited.

If the factory-built fireplace has no gas access hole(s) provided, an access hole of 1.5” dia. (37.5mm) or less may be drilled through the lower sides or bottom of the firebox in a proper workmanship like manner. This access hole must be plugged with non-combustible insulation after the gas supply line has been installed.

Clearances to Combustibles

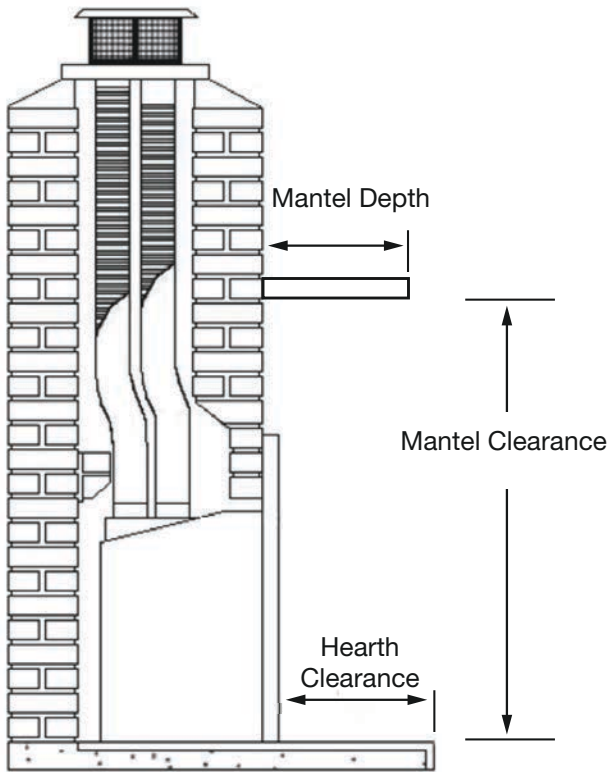

Figure 4: Mantel clearance.

Mantel Clearances	
i20	30" from fireplace floor to mantel
Mantel Depth	
i20	14"
Hearth Clearance	
i20	0"
Objects in front of Appliance	
i20	36"
Under Appliance	
i20	0"

Horizontal Clearances

Horizontal clearance to adjacent sidewall combustibles. Refer to Figure 5.

i20	18" from center of fireplace to nearest combustible or to backing plate, whichever is furthest.
-----	-------------------------------------------------------------------------------------------------

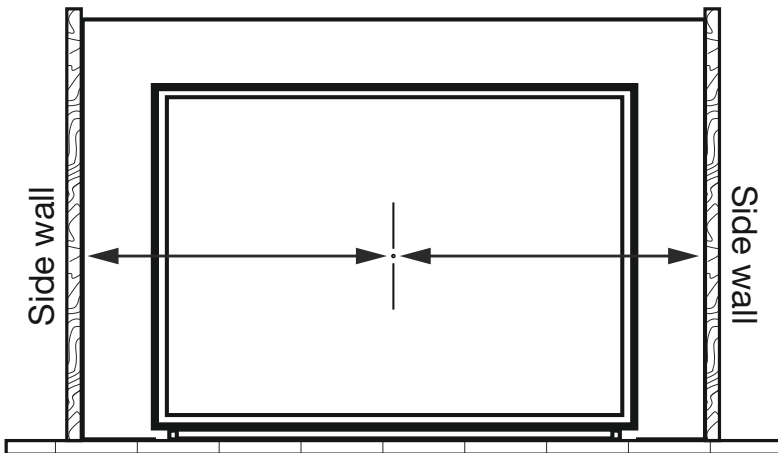

Figure 5: Horizontal clearance to combustibles.

- Fireplace Surrounds and oversize backing plates for larger fireplace openings located on page 8.

Adjustable Leveling Bolts

Adjustable leveling bolts

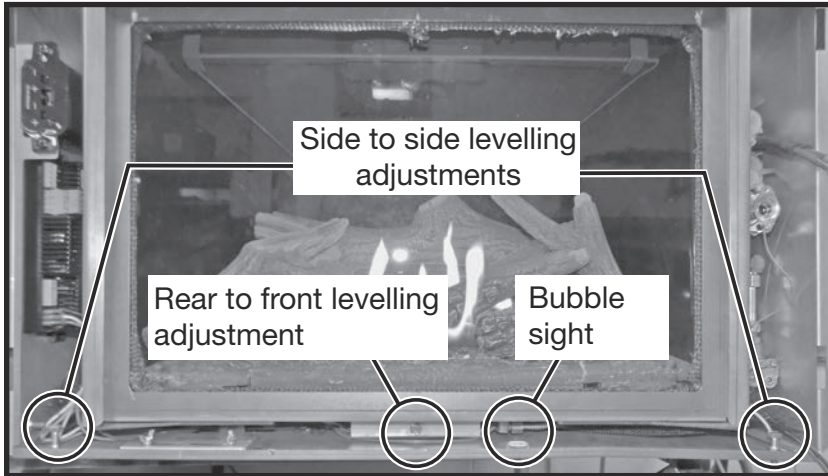

Figure 6: Leveling adjustments.

This fireplace comes with two leveling bolts (Figure 6) used to adjust the angle of the front of the fireplace relative to the wall in which it's installed. The bolts are pre-installed. There is also a single rear leveling adjustment bolt located at the center of the bottom floor. Use these adjustments along with the bubble sight (Figure 7) to level the Tofino fireplace.

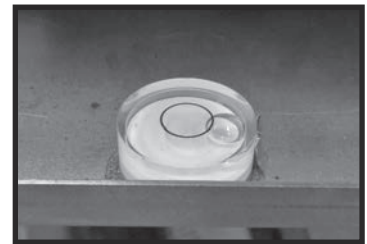

Figure 7: Bubble sight.

Removable Handles

The handles used to lift and maneuver the Tofino into position can be removed in order to accommodate a narrower horizontal fireplace opening. By removing each of the two handles, a full 1 1/2" can be saved.

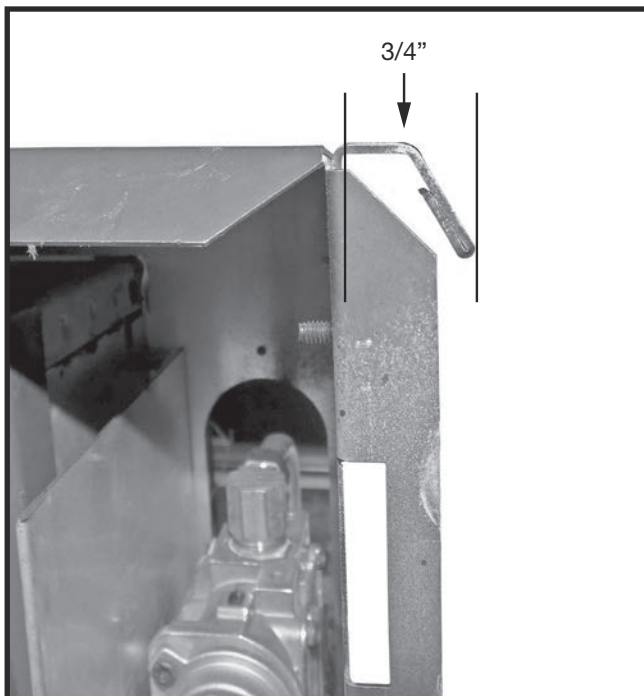

Figure 8: Removable handles.

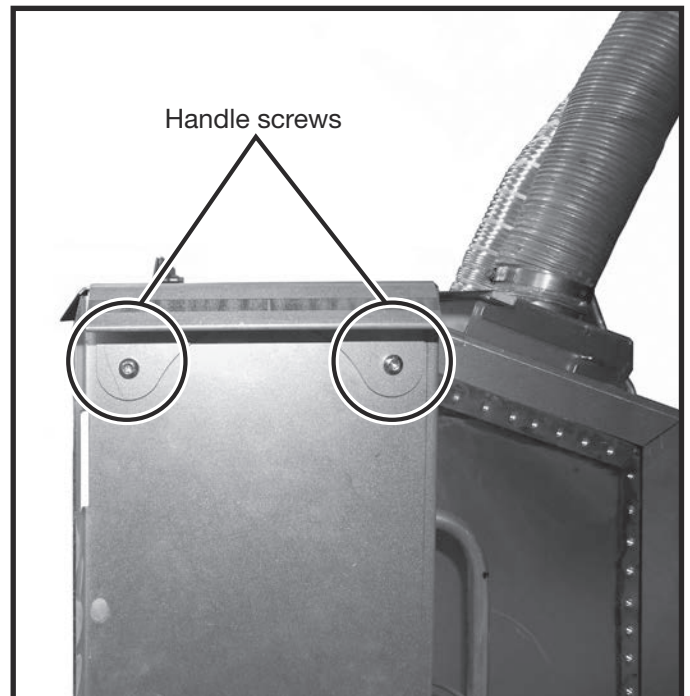

Figure 9: Removable handle screws.

Venting

Only certified venting systems or components may be installed with this fireplace.

Only the following vent terminals should be used for the Tofino i20.

Tofino i20		
Manufacturer	Model	Model number
Duravent	High wind terminal	DVA-CL33
ICC	Co linear terminal	CT3

1. Measure chimney height, cut flex liner (min.10') as required. Mark one pipe at both ends to identify combustion air intake pipe from flue outlet pipe.
2. Attach marked flex liner pipe to the intake side of vent terminal. Seal and secure with sealant and screws provided. Attach the other pipe to the outlet side of vent terminal. Seal and secure with sealant and screws provided.
3. Insert both flex liners from top of the chimney, down through the damper opening.
4. Attach and seal according to vent terminal manufactures' instructions.
5. For larger chimneys, a flashing may be cut and fitted to suit. Caulk the flashing in place to seal any gaps.

Max Vent Height
40' (12.2m)

Min. Vent Height
10' (3m)



Combustion Air Intake Exhaust Vent

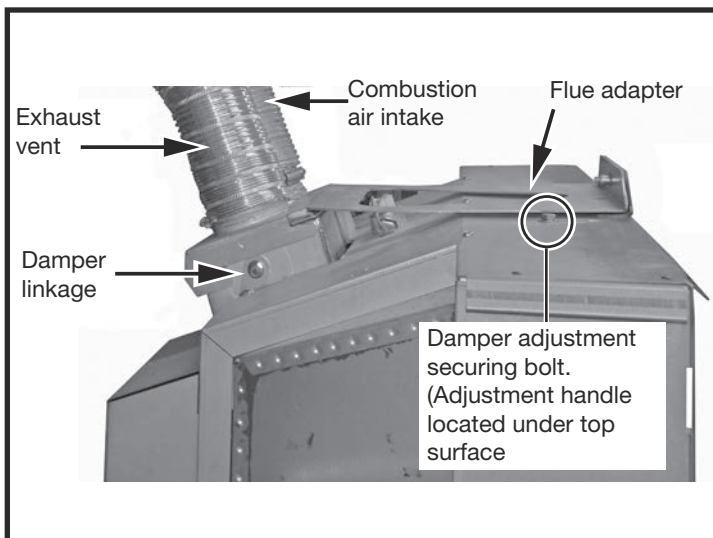
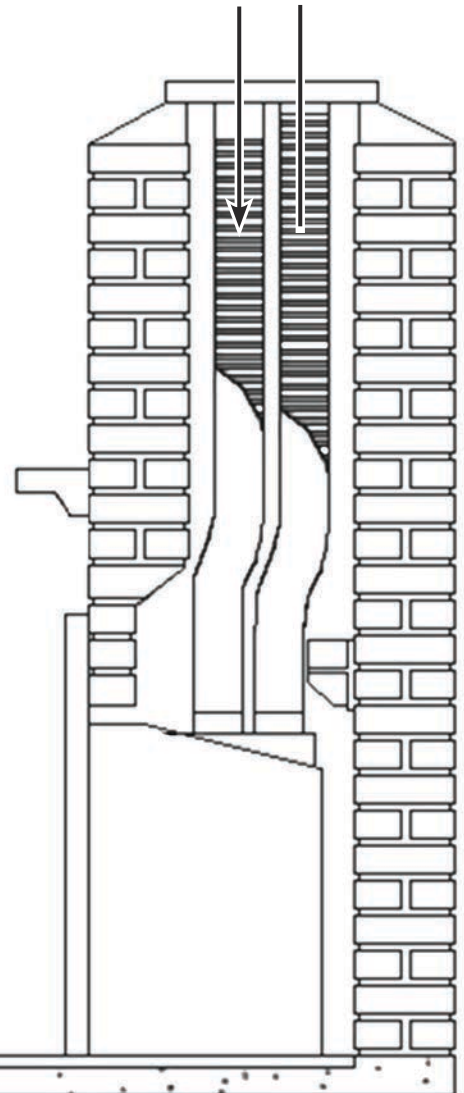

Figure 10: Flue adapter components.

Figure 11: Co linear venting.

Flue adapter

The Tofino i20 uses 3" flex tubing for both the air intake and air exhaust. The Tofino i20 ships with a flue adapter which fits onto the top of the firebox and is affixed with a connection bolt (Figure 13). The flex tubing extending down from the chimney attaches to the flue adapter. Depending on the amount of room available for the installation of the Tofino, the installer may want to remove the flue adapter and attach it to the flex tubes which will have previously been inserted down the chimney. The installer must make sure that the air intake vent and exhaust vents attach to the correct ports on both the flue adapter and the vent terminal. The vent terminal and the flue adapter are marked with an "I" and "E".

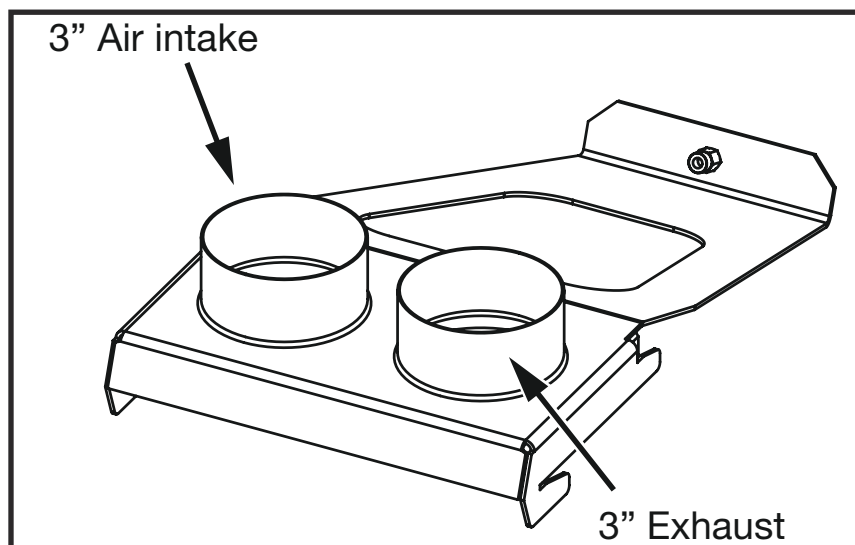

Figure 12: 3 x 3 inch Flue adapter.

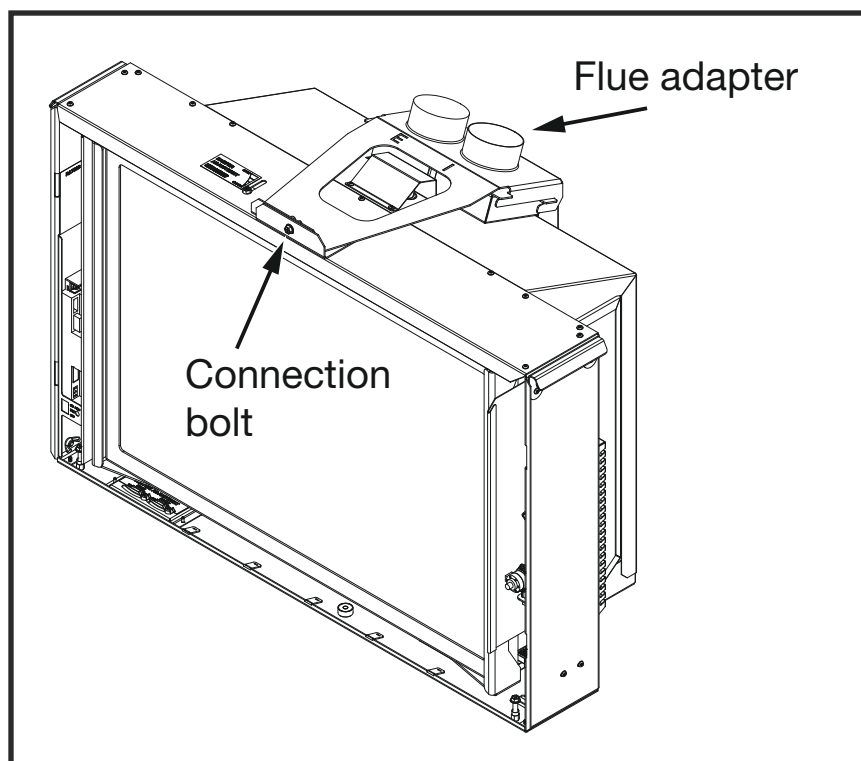

Figure 13: Tofino with flue adapter mounted.

SIT Control Overview

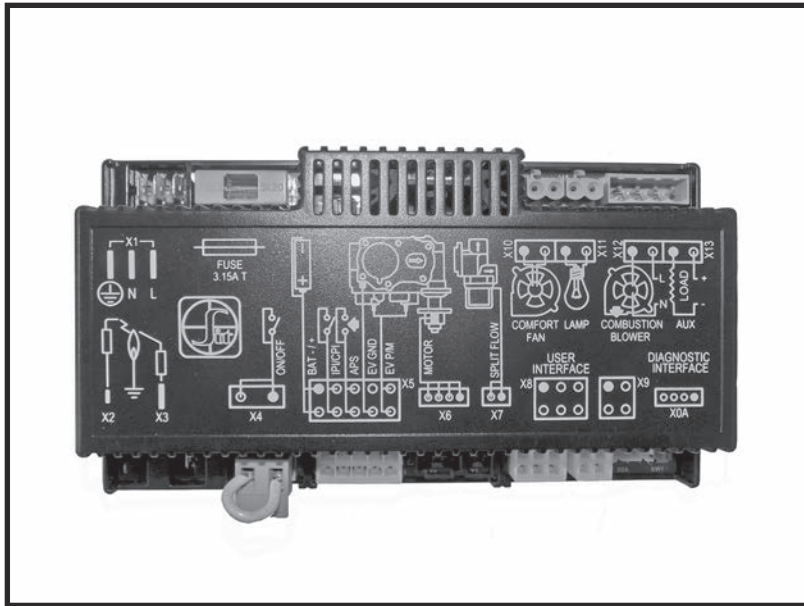

Figure 14: SIT electrical controller.



Figure 15: Proflame - SIT remote control device.

The SIT Proflame controller (Figure 14) is used along with the SIT Proflame gas valve (See “Figure 39” on page 20) . The use of the SIT Proflame controller requires a remote control device (provided) unique to the SIT Proflame configuration. Instructions for using the SIT Proflame remote control device are found Tofino Operating Instructions manual. The SIT module uses 4 AA batteries. The SIT Proflame remote control unit uses 3 AAA batteries.

Maxitrol Control Overview

The Maxitrol controller (Figure 16) is used along with the Maxitrol gas valve (Figure 41 on page 21). The use of the Maxitrol controller requires a remote control device (provided) unique to the Maxitrol configuration. Instructions for using the Maxitrol remote control device are found in the Tofino Operating Instructions manual. The Maxitrol module uses 4 AA batteries. The Maxitrol remote control unit takes 2 AAA batteries.

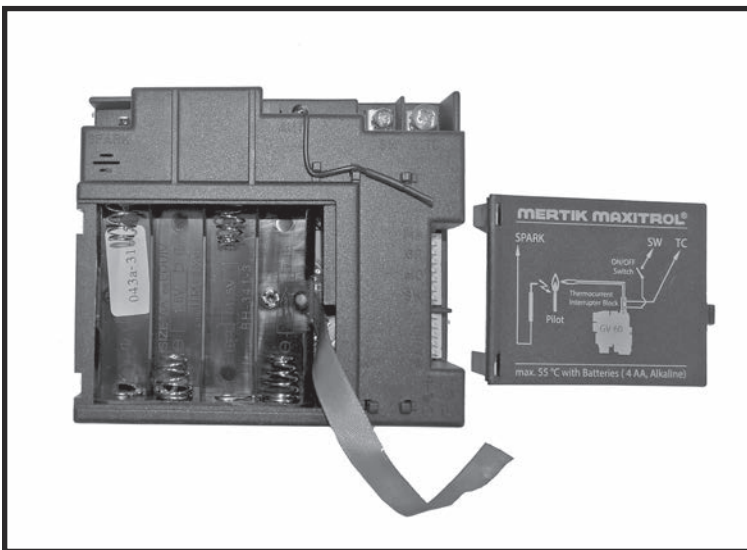

Figure 16: Maxitrol electrical controller.



Figure 17: G6R remote.

Door Installation/Removal

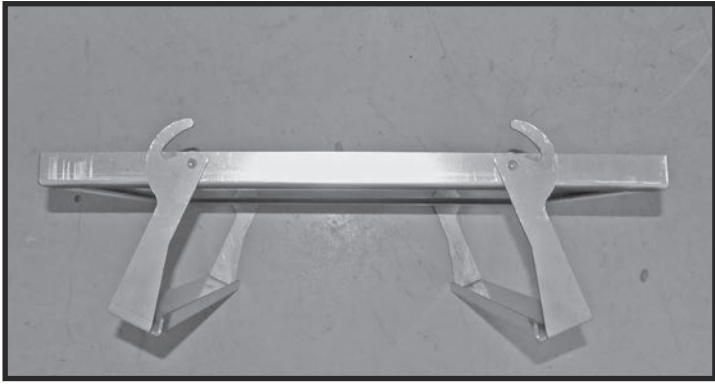

Figure 18: Glass door and hooks.

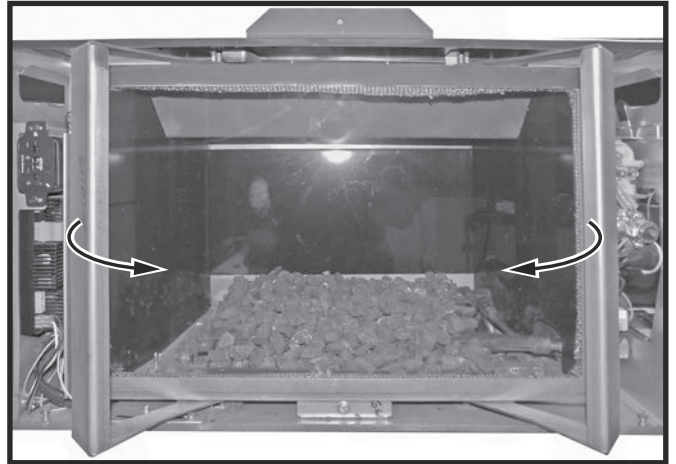

Figure 19: Unlocking the glass door.

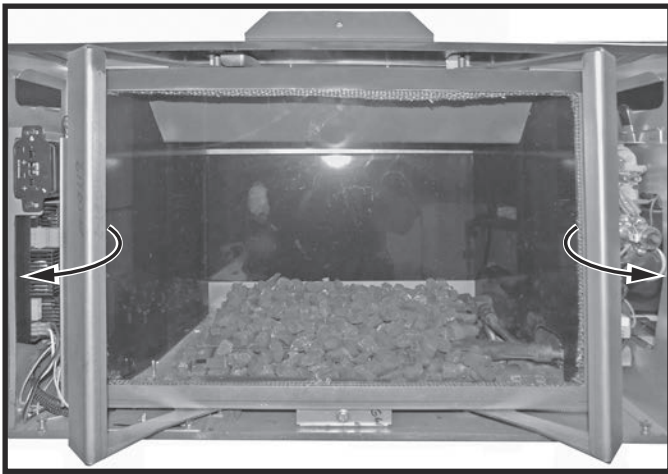

Figure 20: Locking the glass door.

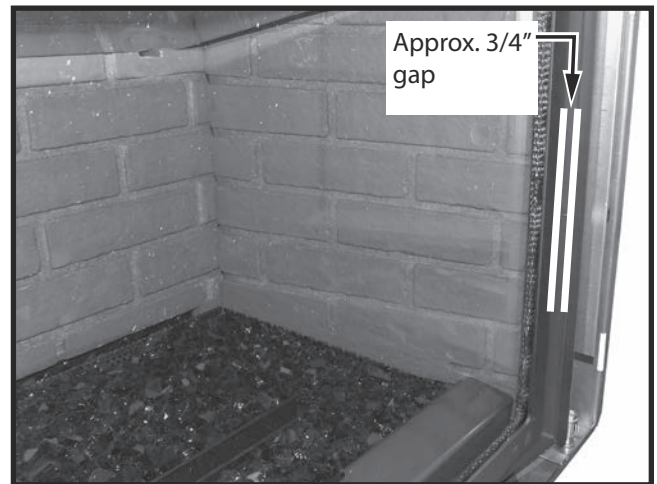

Figure 21: Door handles in closed position.

Removal

1. Remove the decorative front and backing plate from the front of the fireplace, "Surround Installation/Removal Instructions" on page 45. Take care to disconnect the wire on the left hand side of the backing plate which attaches the switch to the interior of the fireplace.
2. There are two handles located on the fireplace door (Figure 18) which must be pulled inward toward the center of the fireplace to unlock the door (Figure 19). This may take some effort because the door completes a tight seal around the firebox.
3. Remove the door and set aside.

Installation

1. Place the door over the opening of the fireplace.
2. There are two hooks on the top of the handles and two hooks on the bottom of the handle and so the door must be placed squarely over the firebox opening.
3. Once the glass door is seated, close the door handles outward and inward until they stop (Figure 20).
4. The handle will not close completely. There will be an approximately 3/4" gap between the handles and the door frame (Figure 21). This is normal.
5. Return the backing plate to its original position making sure to reconnect the switch wire to the backing plate. Return the surround to its original position.

Panel Installation

The panel sets are delicate and should be handled with care.

The baffle and panel support bracket (Figure 22) retains the side panels, supports the front end of the ceramic glass baffle, and has a shield which directs the light from the ceiling of the firebox (available on i20s models only) down onto the log set (model dependent). It is held in place by two bolts. The bracket and its bolts should be removed before installing the rear and side panels so that the bolts protruding from the ceiling do not damage the panels.



Figure 22: Baffle and panel bracket.

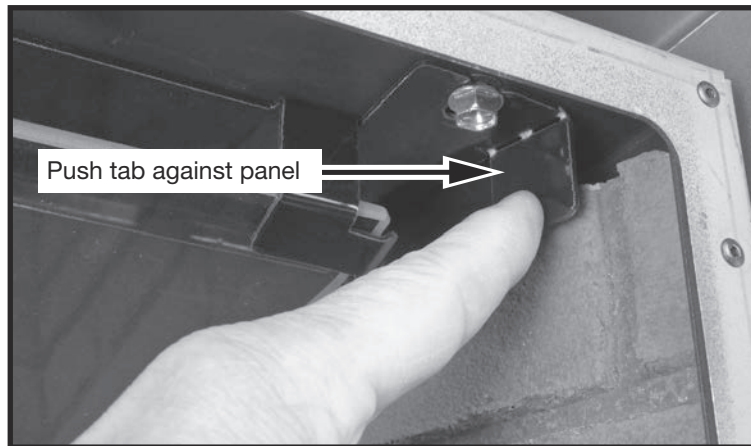

Figure 23: Perforated panel tab.

Note: The baffle and panel bracket (Figure 22) has a perforated tab at each end (Figure 23). This allows the tabs to be easily bent against the decorative side wall panels to hold them in place if necessary. Use only enough force to hold the panel in place and not so much as to damage the panel.

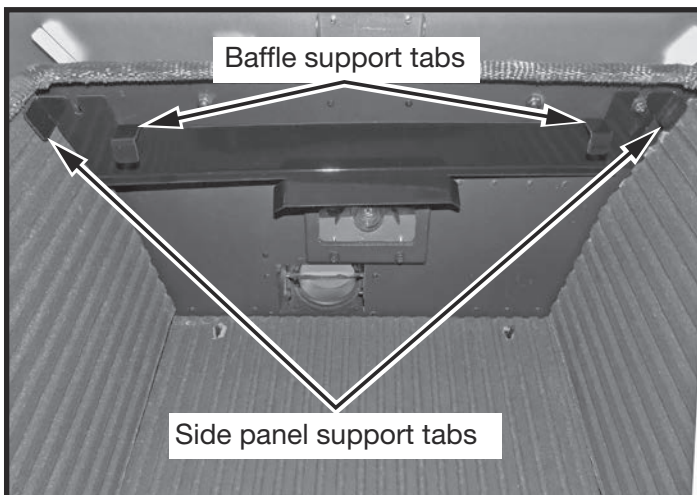

Figure 24: Baffle and panel bracket supporting side panels.

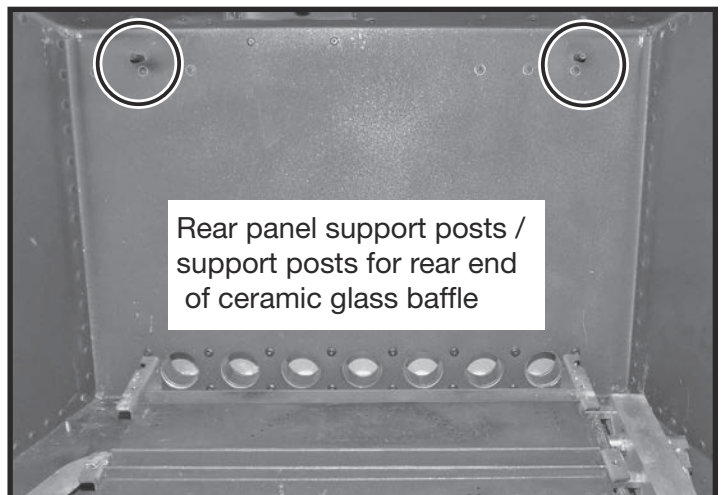

Figure 25: Rear wall showing panel support posts.

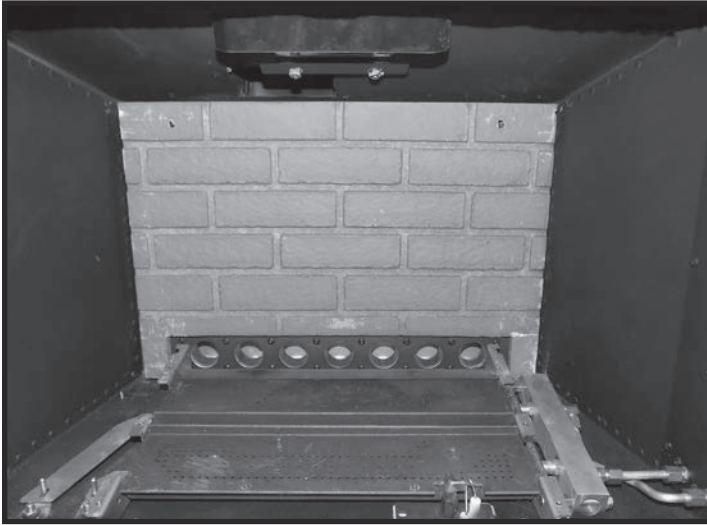

Figure 26: Rear panel in place.



Figure 27: Upper corner.

Installation

1. With the above mentioned support bracket and bolts removed, hang the rear panel onto the posts protruding from the rear wall (Figure 25 and Figure 26).
2. Gently place the base of either of the two side panels along the edge of the firebox floor and wall. Then slowly tilt the top part of the panels up into the edge of the wall and ceiling. Be careful that the top corner of the panel closest to the front of the fireplace makes as little contact with the opening edge of the firebox (Figure 27) as possible as this may damage the panel.
3. The rear panel is stabilized once the side panels are in place. Stabilize the side panels by installing the glass baffle and panel bracket (Figure 22) and its bolts.
4. Install the ceramic glass baffle as outlined in “Installing the ceramic baffle:” on page 18.



Figure 28: Right side panel in place.

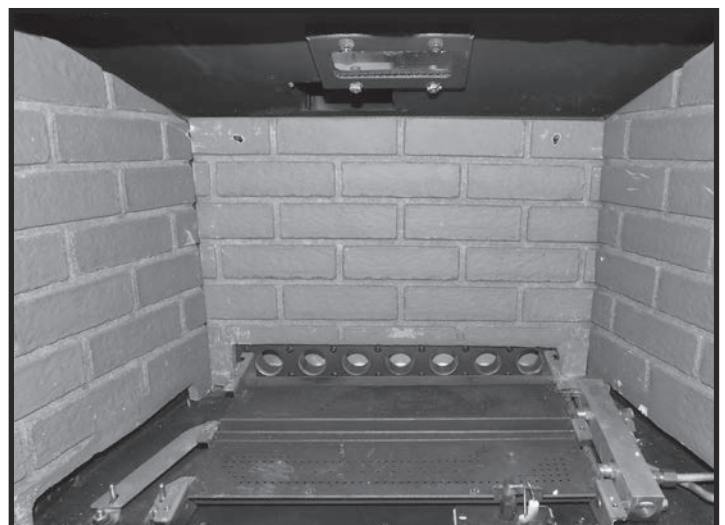

Figure 29: Left side panel in place.

Baffle

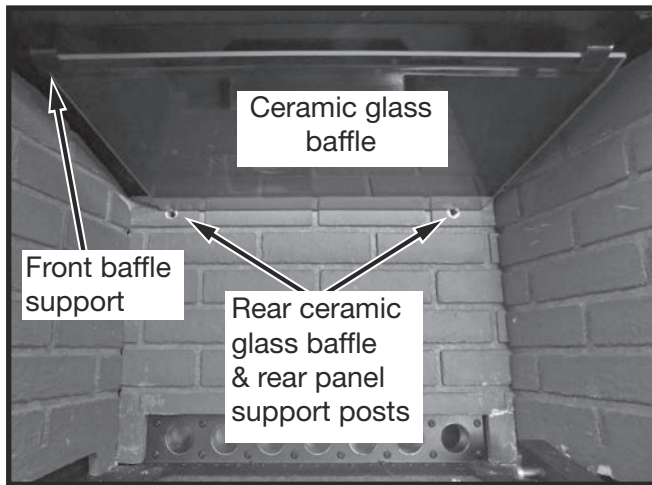

Figure 30: Ceramic glass baffle.

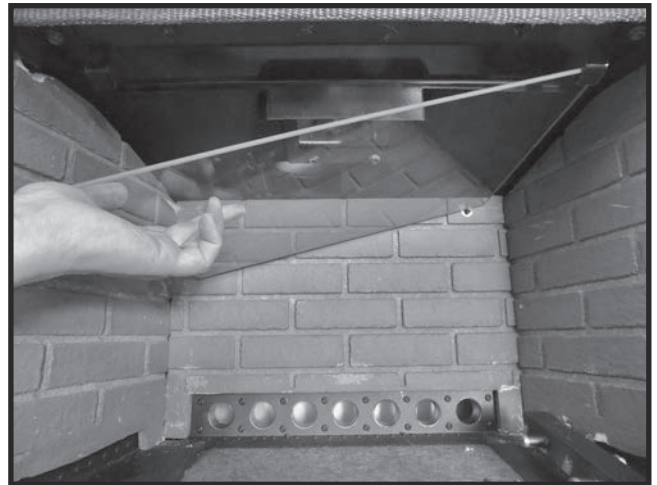

Figure 31: Inserting baffle into the upper corner.

The baffle is made of ceramic glass which allows for the use of a halogen lamp feature. The halogen lamp is only available on units using the SIT Proflame configuration, the Maxitrol configuration does not include the use of a halogen lamp.

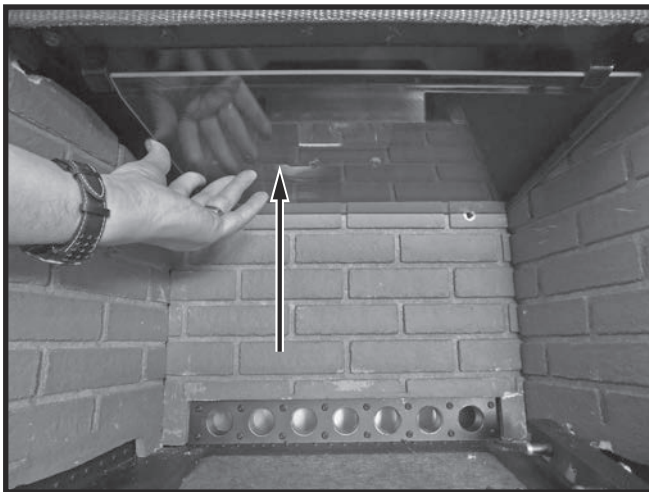

Figure 32: Raising baffle above front support.

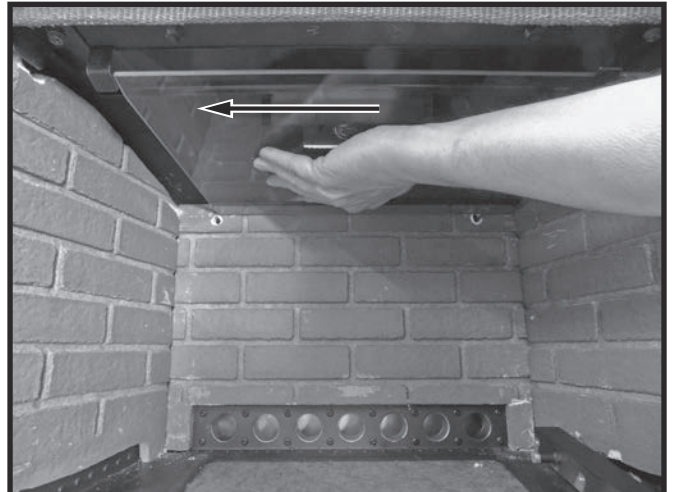

Figure 33: Sliding baffle over to rest on top of supports.

Installing the ceramic baffle:

1. With the door removed, place one end of the baffle over one of the two upper corners so that the baffle is resting on a rear peg and a front support (Figure 31).
2. Raise the opposite end of the baffle so that it is raised above the supports on the other side of the firebox (Figure 32).
3. Slide the baffle over so that it is supported by all four supports (Figure 33).

Cleaning the ceramic glass baffle:

Note: Do not clean the ceramic glass baffle until the fireplace has been turned off long enough for the glass door and ceramic baffle to sufficiently cool down. It is not necessary to remove the ceramic baffle in order to clean it but the ceramic baffle is easily removed. Use glass cleaner to clean the ceramic baffle of soot or other debris.

Electrical Supply

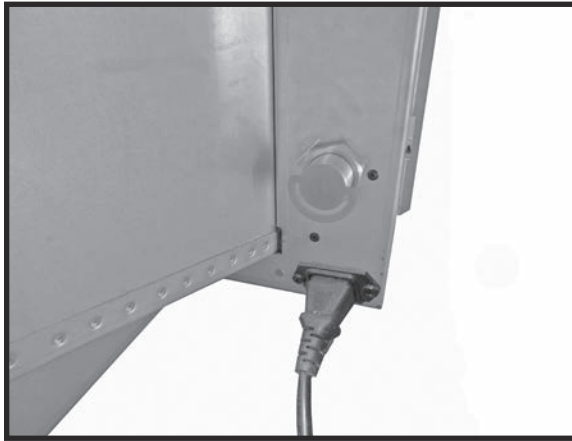

Figure 34: Electrical connection.

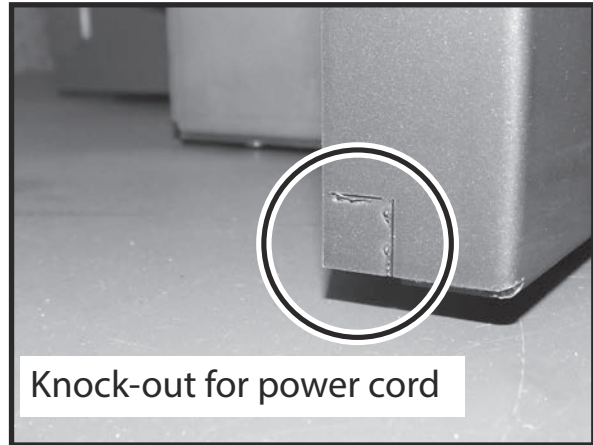

Figure 35: Knock-out for power cord.

Note: SIT controlled installations require that an electrical outlet be installed either into an existing fireplace cavity before the Tofino is installed, or alternatively, the power cord can access a pre-existing power outlet elsewhere in the room by way of knock-out openings located on either side of the backing plate (Figure 35).

NOTE: The appliance, when installed must be electrically grounded in accordance with local codes or, in the absence of local codes, with the National Electrical Code, ANSI/NFPA 70, or the Canadian Electrical Code, CSA C22.1.

Gas Supply

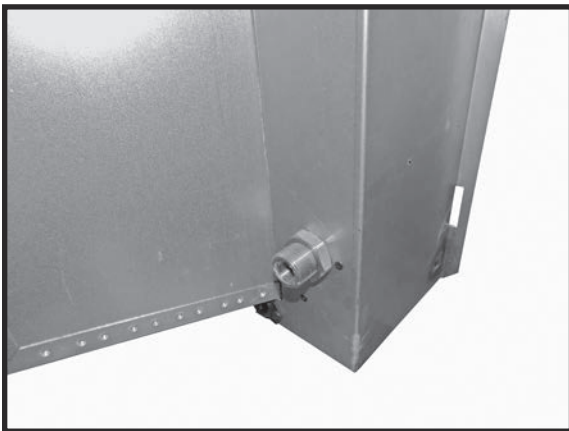

Figure 36: Tofino gas connection.

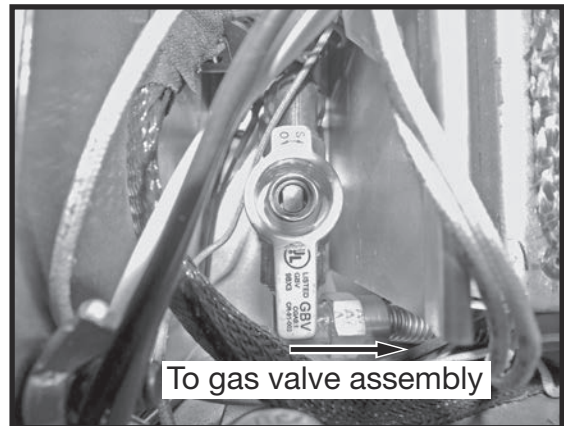

Figure 37: Gas shut off valve.

Caution: The gas line should be installed by a qualified service person in accordance with all building codes. This section is intended as a guide for qualified technicians installing this appliance. Consult local and/or national building codes before proceeding.

- Gas supply line connection is located on the left rear side of the insert (Figure 36). Gas connection accepts a 3/8" N.P.T. fitting. Correct gas line diameter must be used to assure proper operation and pressure. **Do not use external threads for gas connections. Use internal threads only.**
- A drip leg must be installed in the gas supply line close to the appliance to minimize the possibility of any loose scale or dirt within the gas supply line from entering the control valve.

Check local codes for additional requirements.

Turn on the gas supply and check that all connections are tight and leak free.

Gas Valve for SIT Configuration

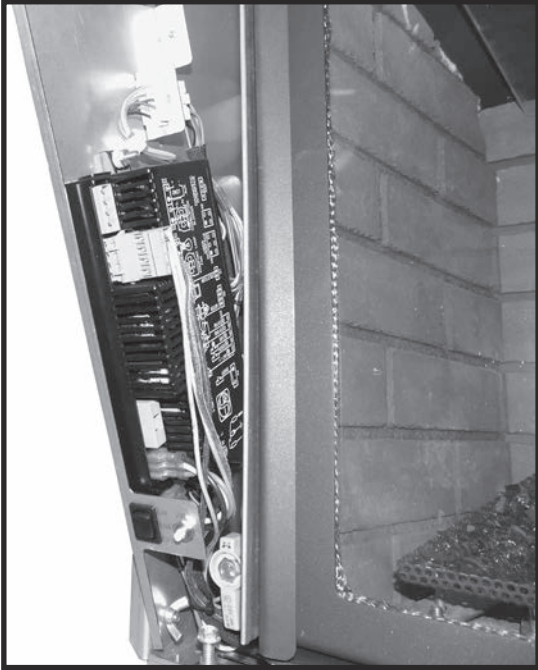

Figure 38: SIT control center.

SIT controller

The SIT controller is mounted onto a caddy which is located on the left hand side of the fireplace for easy access. Remove the surround to gain access to the controller.

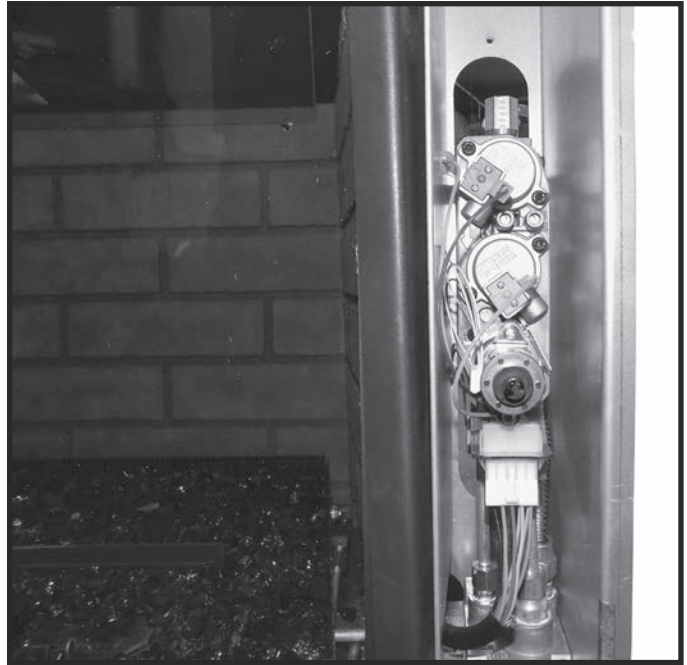

Figure 39: SIT Gas valve.

SIT gas valve

The SIT gas valve assembly is mounted onto a caddy which is located on the right hand side of the fireplace for easy access. Remove the surround to gain access to the controller.

Gas valve for Maxitrol Configuration

Maxitrol controller

The Maxitrol controller is mounted onto a caddy which is located on the left hand side of the fireplace for easy access. Remove the surround to gain access to the controller.



Figure 40: Maxitrol electrical controller in its caddy.

Maxitrol gas valve

The Maxitrol gas valve assembly is mounted onto a caddy which is located on the right hand side of the fireplace for easy access. Remove the surround to gain access to the controller.

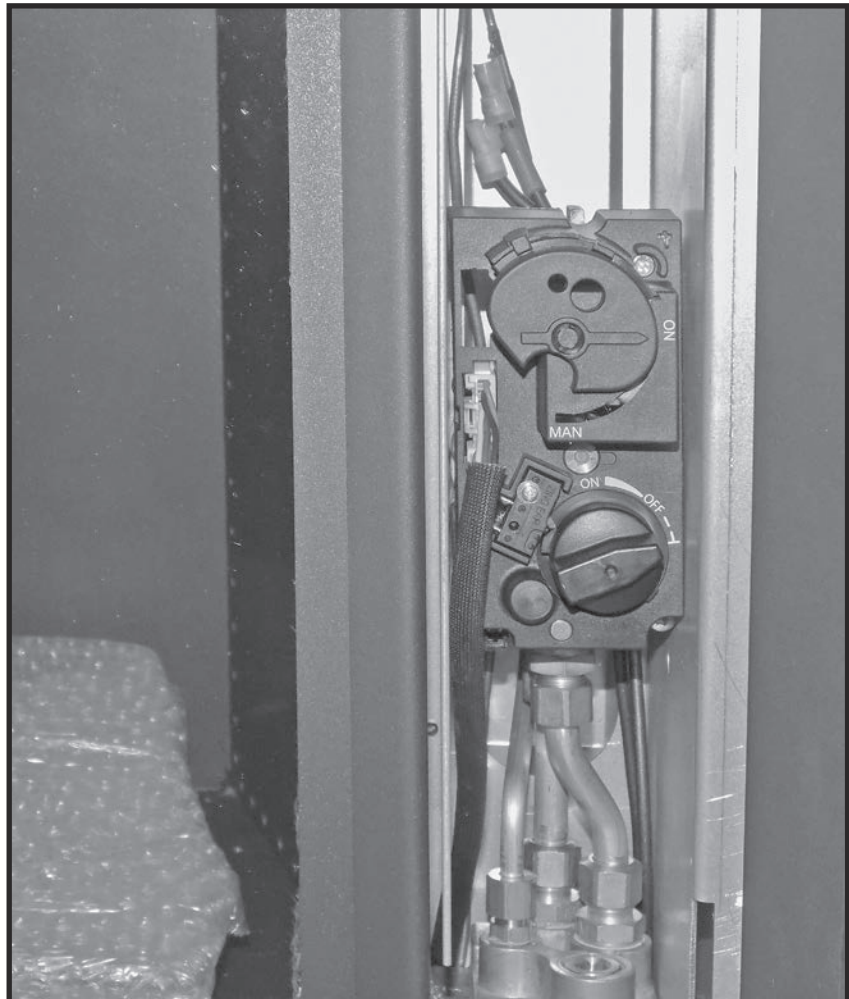

Figure 41: Gas valve for Maxitrol configuration.

Gas Pressure Check / Output / Efficiency

Please refer to following page for gas pressure testing procedure.

SIT Valve		
Gas pressure requirements		
<u>Input Pressure</u>	<u>Natural Gas</u>	<u>Propane</u>
Minimum	5.0" WC	12.5" WC
Maximum	13.9" WC	13.9" WC
<u>Manifold Pressure</u>		
High	3.5" WC	10" WC
Low	1.7" WC	6.4" WC

Maxitrol Valve		
Gas pressure requirements		
<u>Input Pressure</u>	<u>Natural Gas</u>	<u>Propane</u>
Minimum	5.0" WC	12.5" WC
Maximum	13.9" WC	13.9" WC
<u>Manifold Pressure</u>		
High	3.8" WC	10" WC
Low	1.7" WC	2.7" WC

Tofino i20 (SIT Version)		
<u>Gas</u>	<u>Orifice</u>	<u>Input</u>
NG	Front AA	20,000 btu/hr (Max) / 6,000 btu/hr (Min)
NG	Rear BA	
LP	Front CA	20,000 btu/hr (Max) / 7,000 btu/hr (Min)
LP	Rear DA	
Tofino i20 (Maxitrol Version)		
<u>Gas</u>	<u>Orifice</u>	<u>Input</u>
NG	Front AA	20,000 btu/hr (Max) / 10,000 btu/hr (Min)
NG	Rear BA	
LP	Front CA	20,000 btu/hr (Max) / 10,000 btu/hr (Min)
LP	Rear DA	

Gas Pressure Testing Procedure

Note: This section covers gas pressure testing for both SIT and Maxitrol gas valves.

Note: To test the gas pressure, turn off the gas supply to the appliance before loosening test point screws. Verify gas pressures with the fireplace lit and at the highest setting.

1. Remove surround.
2. Locate the inlet and outlet test points on the valve which can be seen in (Figure 42). After locating test ports loosen the cap ends within the ports using a 3/16" Allan key.
3. If necessary, attach brass test extensions to the test ports. Extensions are not included (Figure 44).
4. Attach one end of hoses to brass extensions and the other end to the pressure gauge.
5. Turn gas supply back on and test pressures.
6. After testing is finished turn off gas supply, remove the pressure gauges, apply thread sealant to cap ends and re-tighten (Figure 45).

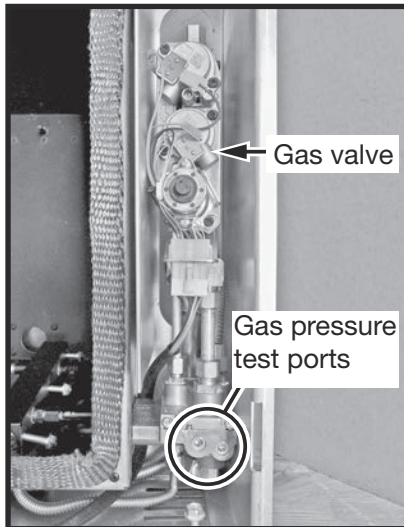

Figure 42: Gas valve location.

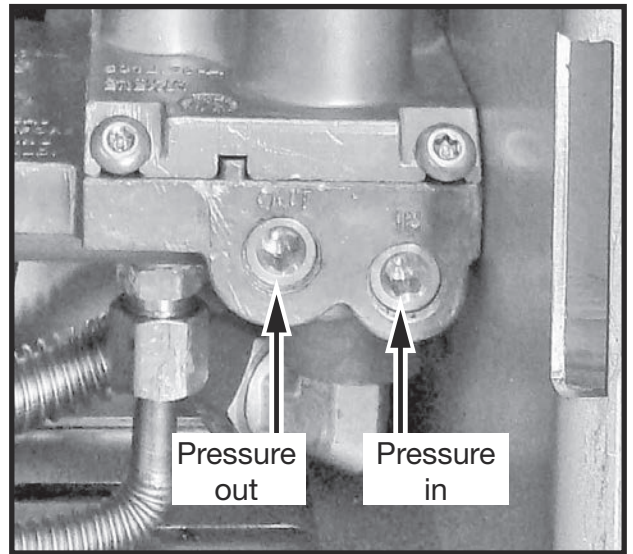

Figure 43: Gas pressure test ports.

Figure 44:
Installer supplied
gas valve test
port extensions.

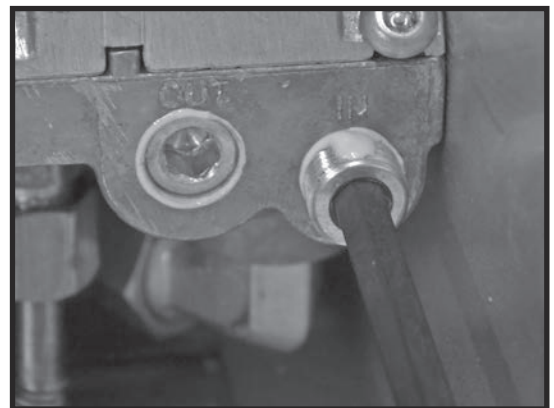

Figure 45: Testing port caps with thread sealant.

Damper Adjustment

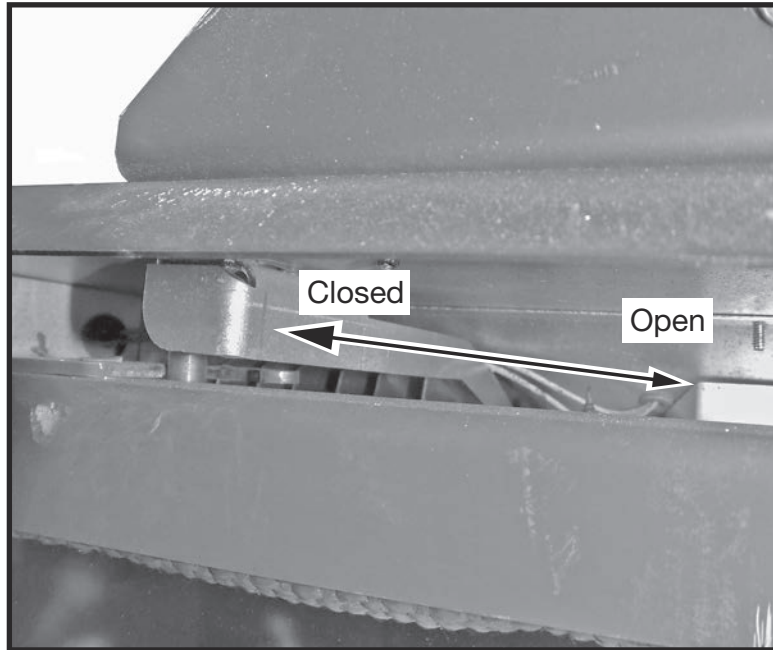

Figure 46: Damper adjustment.

Note: Be aware that the damper adjustment mechanism may be hot if the fireplace has been burning for any length of time.

Tofino fireplaces come with an adjustable vent damper. This damper is located behind the air deflector at the rear of the inner firebox. Sometimes on installations that involve vertical venting configurations over 10 feet in height (10 feet is the minimum height), the intake air tends to accelerate down the vent causing hectic flame action. This damper can be closed partially to reduce the speed of the intake air and thus calm the flames to a more natural look. Over-closure of this damper could cause an insufficient air supply to the fire, which would result in flames that cause soot.

Damper Adjustment:

To adjust the damper, locate the bolt (10 mm or Phillips) on top of the fireplace at the front (Figure 47). Loosen it and adjust the lever directly below the bolt and guide label (Figure 46).

- To close the damper (for a 40' flue), push the adjustment mechanism away from you.
- To open the damper (for a 10' flue), pull the adjustment mechanism toward you.



Figure 47: Damper adjustment indicator.

This is a guide only. Specific installations may require alternate adjustments.

Venturi Adjustment

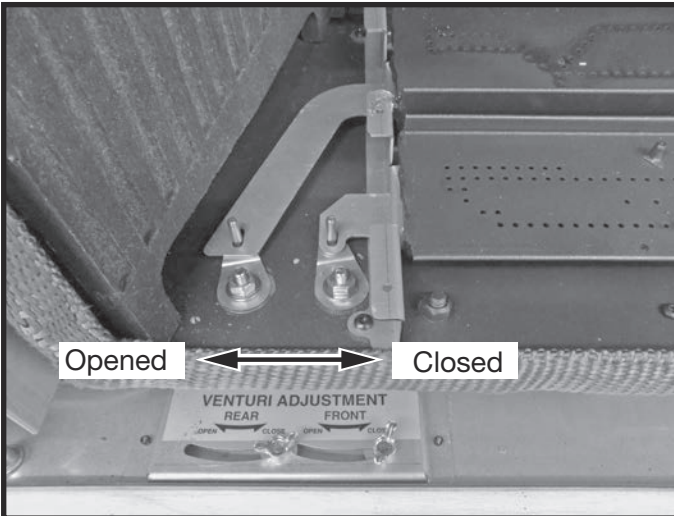

Figure 48: Tofino venturi adjustments.

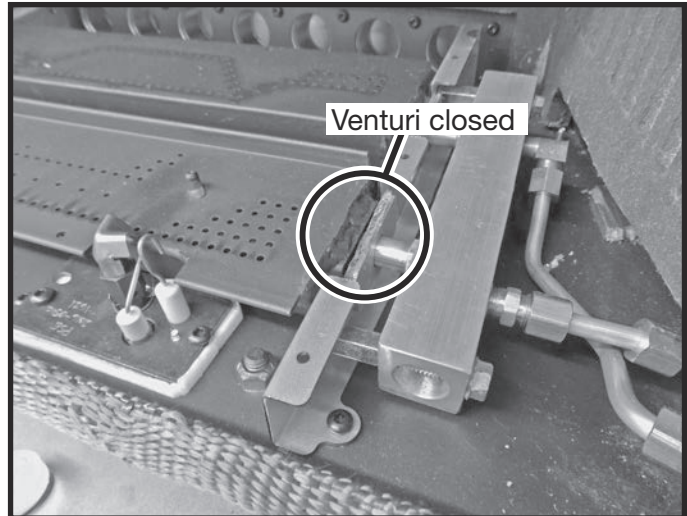

Figure 49: Venturi closed.

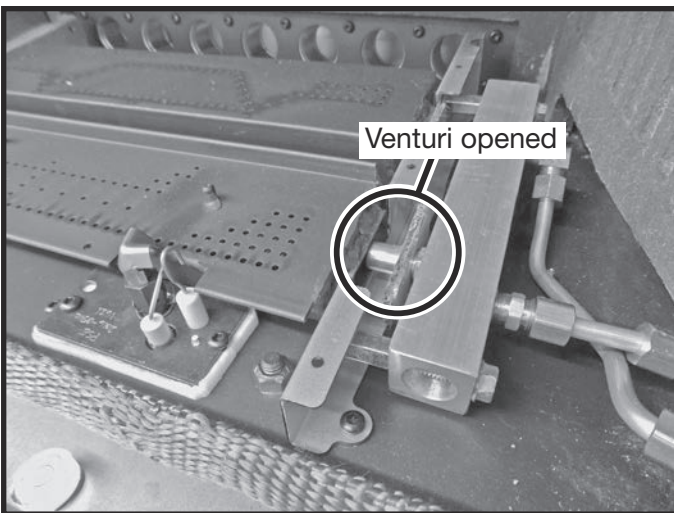

Figure 50: Venturi opened.

The Tofino has two burners and therefore, two venturis. The venturis are easily accessible and adjustable without having to remove the door.

To adjust the venturis:

1. With the fireplace turned off, check that the surround is cool to the touch.
2. Remove the surround from the fireplace.
3. With the fireplace turned on, use the adjustments (Figure 48) to adjust for flame appearance.

Note:

The venturi settings on the Tofino i20 units come preset from the manufacturer. Units that use natural gas come with the venturi adjustment set at the fully closed position while units that are configured for propane gas have their venturi adjustment set at the fully open position. It may be necessary for the installer to make a minor adjustment, whether using a natural gas model or a propane gas model, to achieve the desired flame pattern and/or to eliminate sooting.

Glass Media Installation

1. With the interior panels and the ceramic glass baffle installed, place the glass burner tray (Figure 51) inside and over the burners and secure in place (total of 10 screws to be used). The panel spacer tabs will hold the panels against the firebox walls to allow for adequate air flow around the perimeter of the burner tray. Place the decorative front edge plate (Figure 52) so that it hooks over the edge of the burner tray. This plate does not fasten to anything and simply rests in place.
2. Add a thin layer of crushed glass on top of the burners and the burner tray (Figure 54). When placing the crushed glass on the burner tray, leave enough room around the pilot and rectifier flame so that it is not impeded.
3. Keep the gap between the two burners free from all crushed glass (Figure 54). This gap is required for air flow.

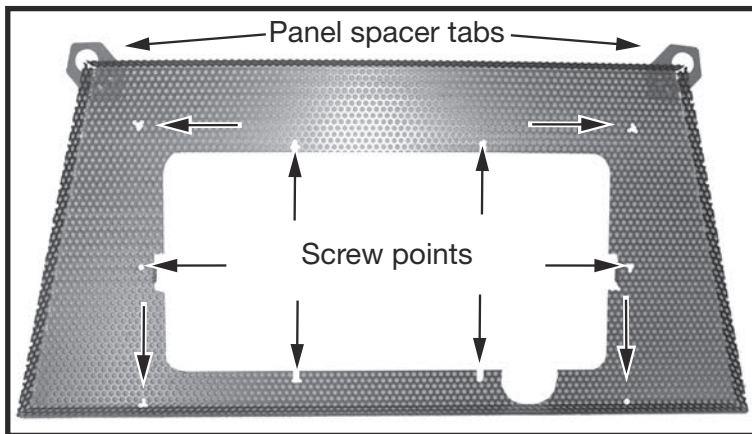

Figure 51: Glass burner tray with panel tabs and screw down points.



Figure 52: Front edge plate.

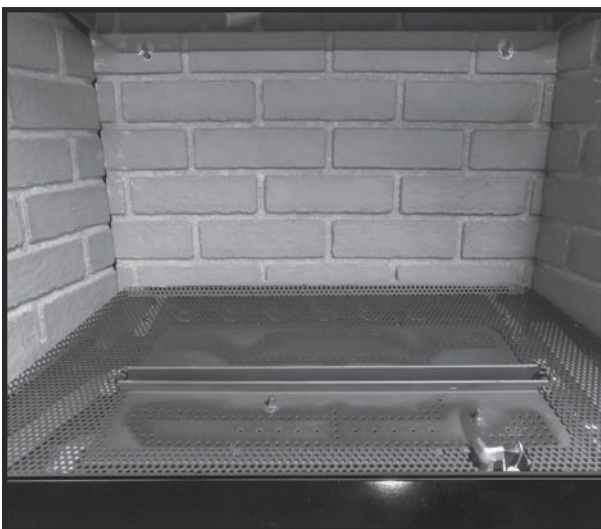

Figure 53: Burner with empty burner tray.

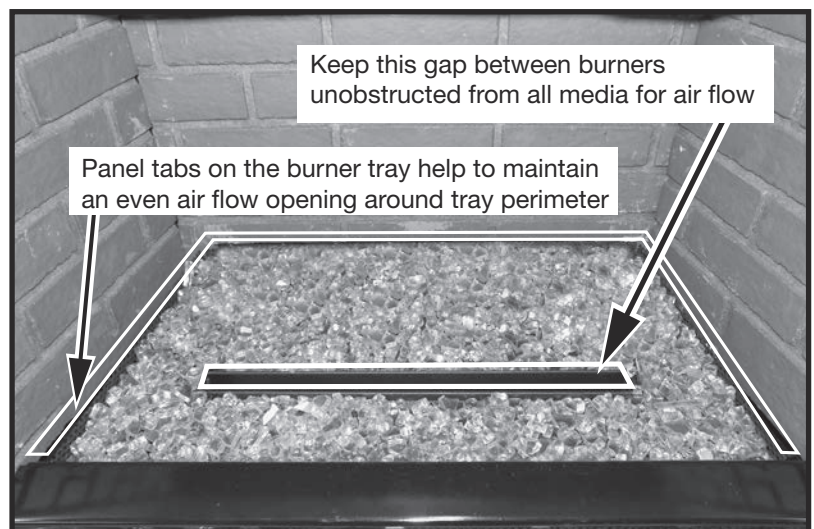

Figure 54: Crushed glass layer.

Split Log Set Installation

Left side
base piece



Right side
base piece



Center base piece



Figure 55: Log set base pieces.

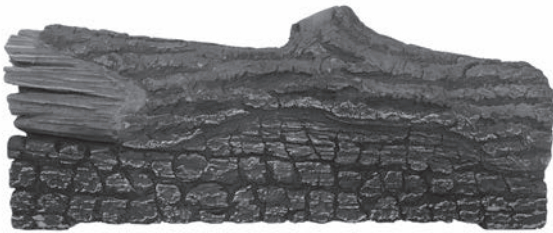

Figure 56: Log number 1.



Figure 57: Log number 2.



Figure 58: Log number 3.



Figure 59: Log number 4.



Figure 60: Log number 5.



Figure 61: Log number 6.



Figure 62: Ember pieces.



Figure 63: Ember wool.

Log set Installation

Note: Panel set must be installed before the Traditional log set installation begins.

1. Begin by placing the air deflector / 1st log support (Figure 64) behind the rear burner and up against the rear wall (Figure 65). Position so that the lip faces toward the front of the fireplace. Fasten the deflector down with supplied screws. Once the deflector is secured, there should be a gap of approximately 1/2 inch between the deflector and the front burner (Figure 66). This gap is required for air flow. Also secure the Ember pieces Retainer (Figure 64) along the back of the rear burner. This will help to keep the ember pieces from spilling over from the burner and down into the air gap.
2. The number one log (Figure 56) will rest on top of the air deflector. However, the bottom front edge of the number one log will rest on top of the air deflector lip as shown in Figure 67.

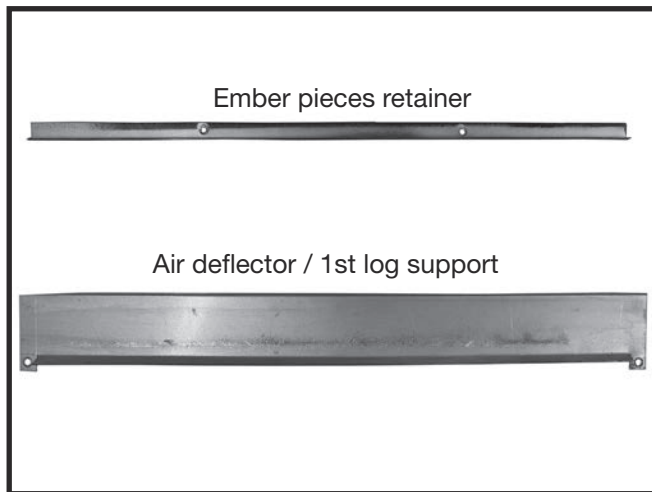

Figure 64: Ember pieces retainer and air deflector-1st log support.

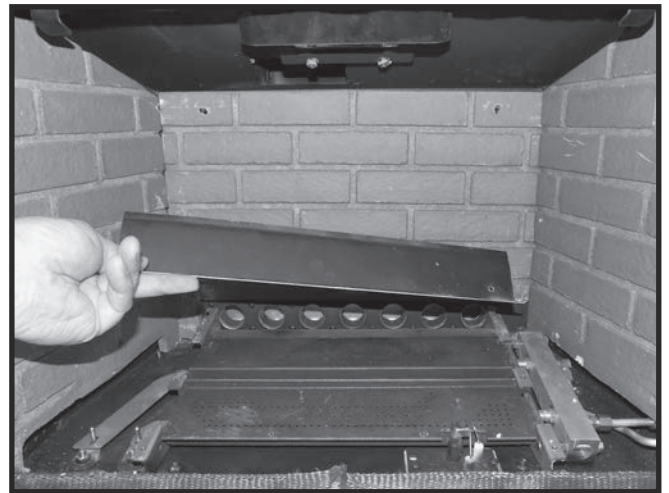

Figure 65: Air deflector.

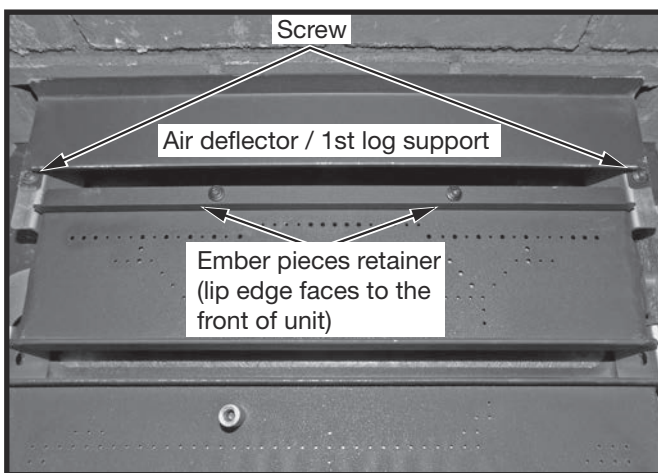

Figure 66: Gap between air deflector and burner.

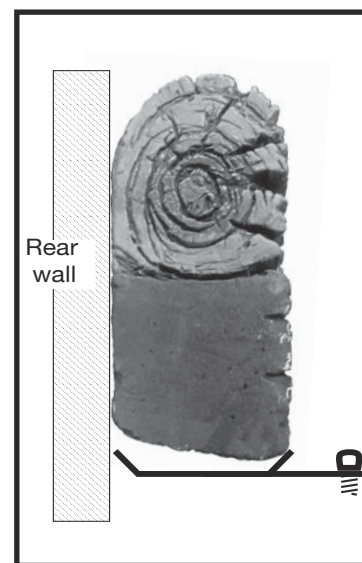

Figure 67: Log one position on air deflector.



Figure 68: Log number one placement.

3. Place number one log on top of the air deflector with its rear side flat against the rear panel (Figure 56).
4. Place the front mesh guard (Figure 69) along the front edge of the front burner. Secure with supplied screws. Fit the guards' gap around the pilot assembly (Figure 70).
5. Place the side mesh guard (Figure 71) on the right of the burners and secure with supplied screws (Figure 72).

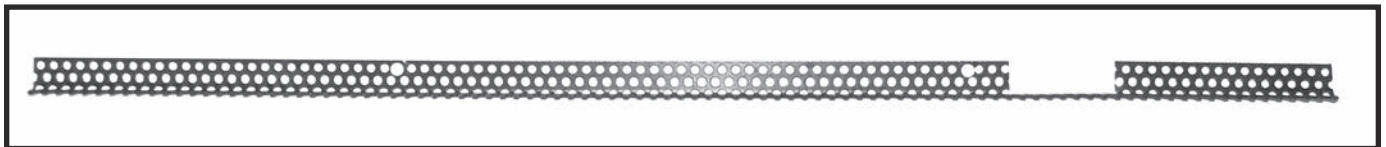

Figure 69: Front mesh guard.

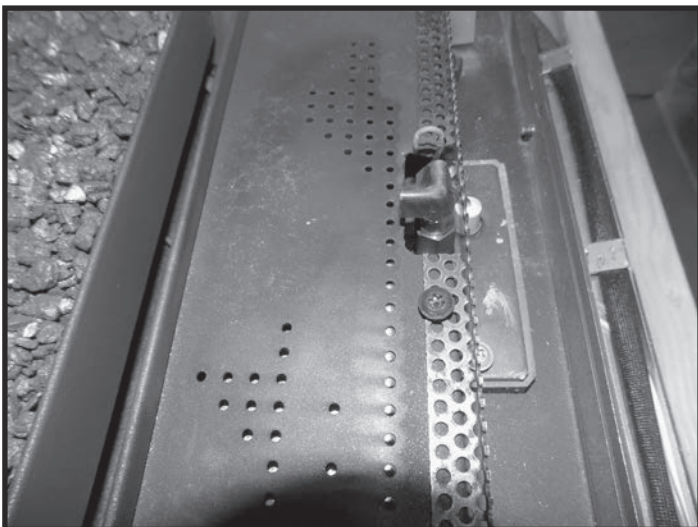

Figure 70: Front mesh guard in place.

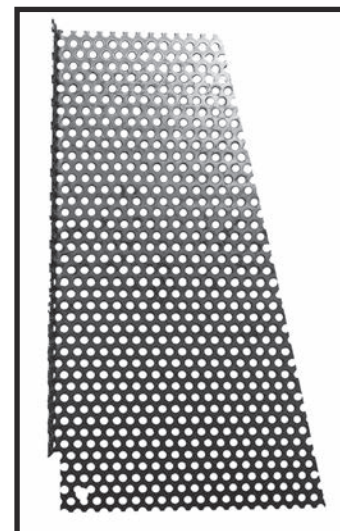

Figure 71: Side mesh guard.

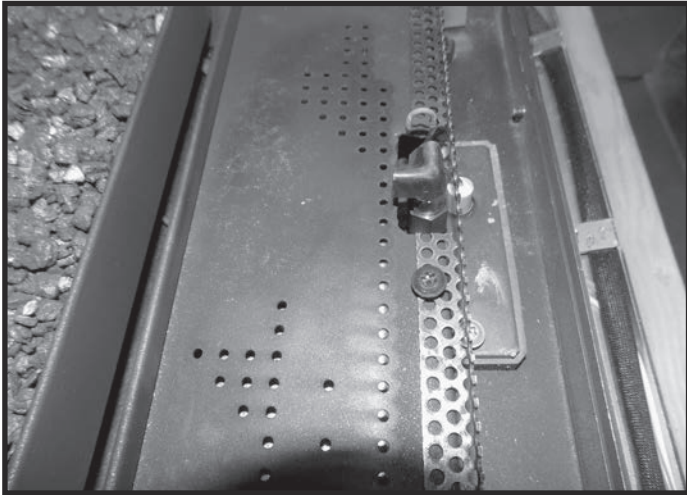

Figure 72: Front mesh guard in place.

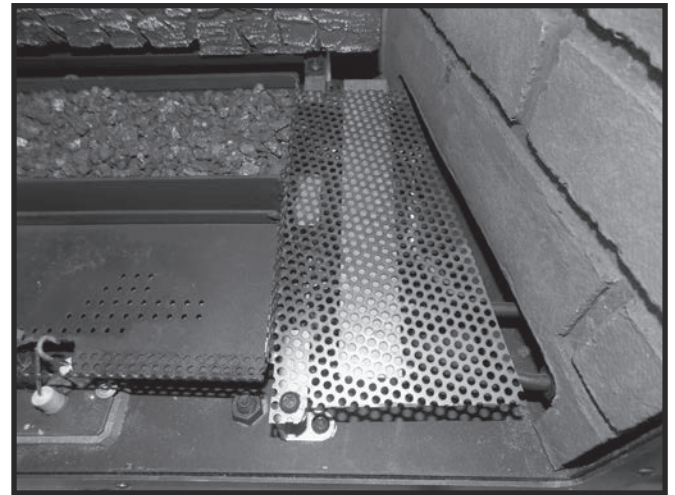

Figure 73: Side mesh guard in place.

6. Once the front and side mesh guards are in place (Figure 72 and Figure 73), the log base pieces can be installed.
7. Install the three base pieces (Figure 55) as shown in Figure 74. The base pieces, in addition to adding an aesthetic dimension to the overall appearance, help to complete an enclosure for holding the ember pieces / glowing ember material pieces on top of the burners. The two side pieces have one hole each to accept the posts protruding from the bottom of logs two and four.
8. Place included metal spacer/support over top of the left-hand side post located on the front burner (Figure 75). This spacer will support the front end of log number two. **Note: Spacer may already be present and fastened to the burner.**

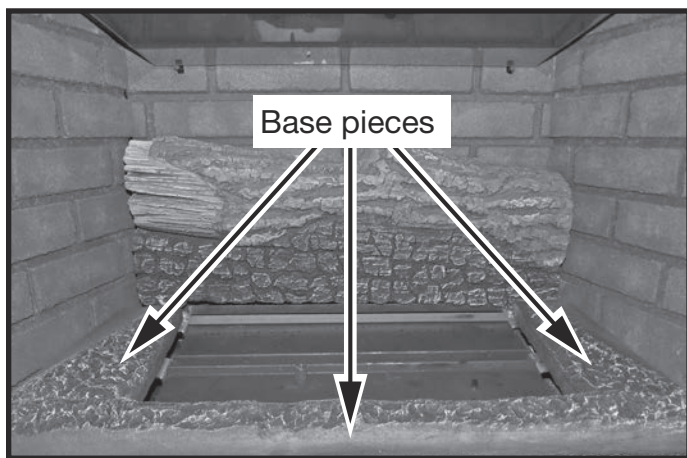

Figure 74: Three base pieces.

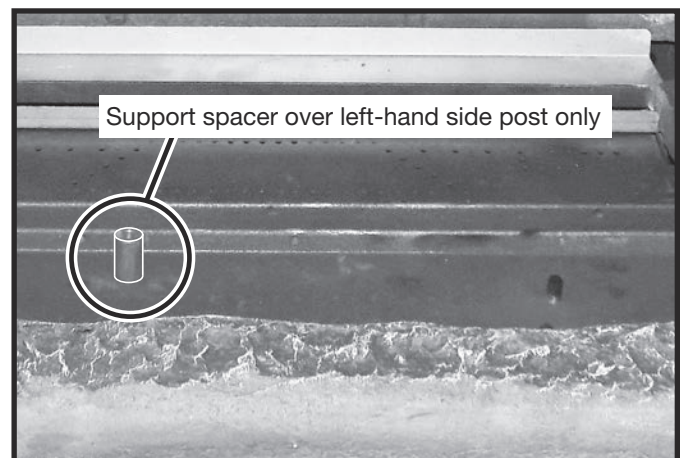

Figure 75: Support spacer over post.

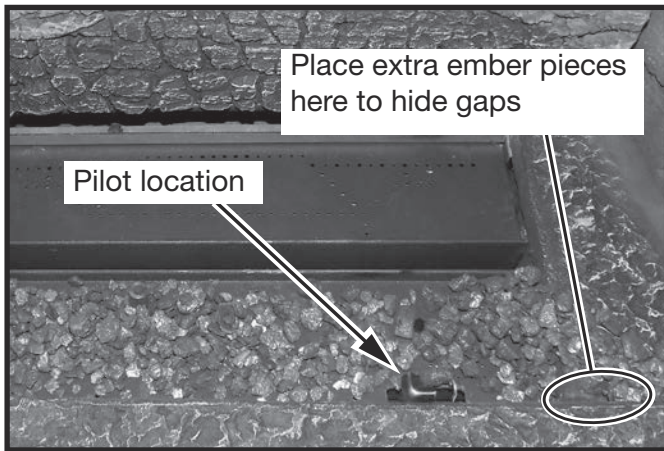

Figure 76: Front tray filled lightly with ember pieces and pilot location.

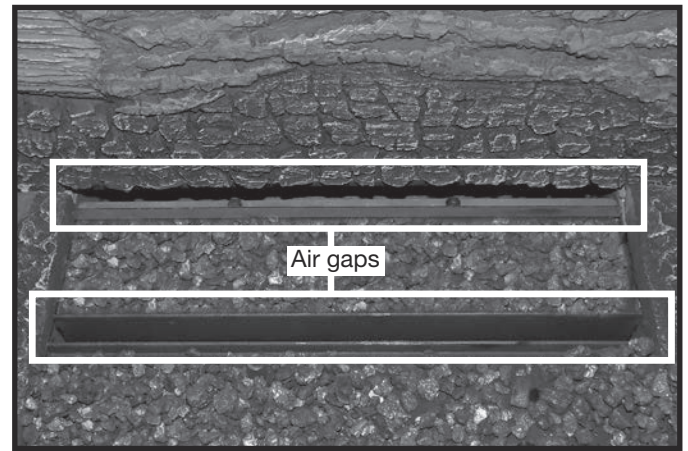

Figure 77: Air gaps.

9. Distribute a thin layer of ember pieces (Figure 62) (1/4" to 1/2") onto the front burner tray (Figure 76). Place extra ember pieces on the thin, but noticeable gaps between the front base piece and the two side base pieces. Keep the ember pieces from interfering with the pilot assembly. Place a layer of ember pieces (1/4" to 1/2") onto the rear burner tray to fill it up until it is level with the side and end walls. Keep the ember pieces from falling into the air gaps between the front and rear burners and the gap between the rear burner and the air deflector which supports the first log (Figure 77).
10. Place log number two (Figure 57) so that the post protruding from the bottom of the log can be inserted into the hole of the left base piece. Then position the front of the log so that it rests on top of the left spacer (Figure 78). The log and the ember pieces should ideally hide the spacer.
11. Place log number three (Figure 58) so that the post protruding from the bottom of the log can be inserted into the hole of the right-hand base piece. Then position the front of the log so that it rests on top of the center base piece (Figure 79). The front of the log should be very close, or just touching, the center base piece.

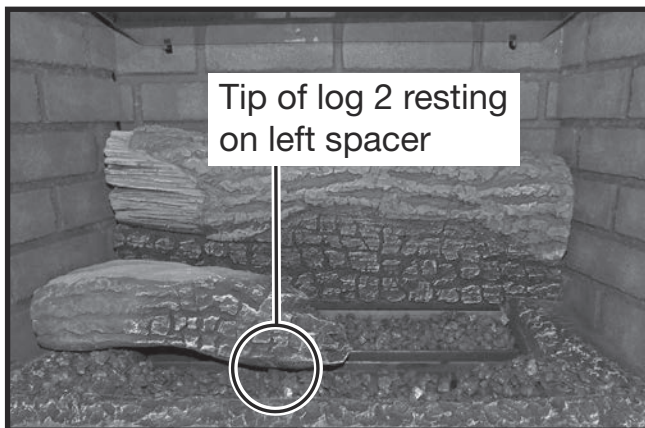

Figure 78: Log 2 positioned on left spacer.

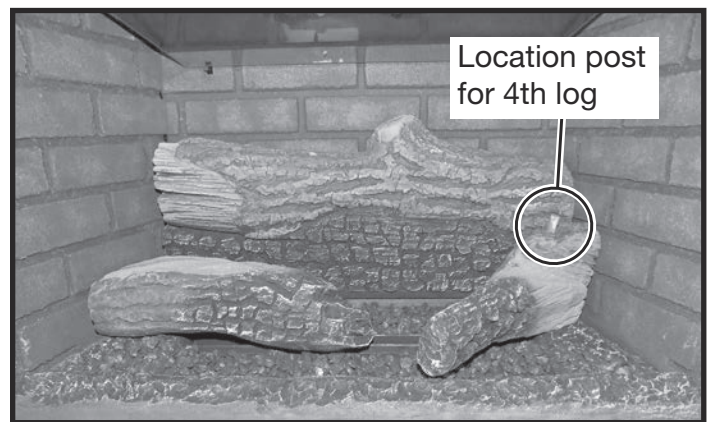

Figure 79: Log 3 placement and location post for log 4.



Figure 80: 4th log placement.



Figure 81: 5th log placement.

12. There is a location post on top of the 3rd log (Figure 79) that is used to accommodate a slot located on the bottom of the 4th log (Figure 59). Place the 4th logs' slot on top of the 3rd logs' post. Position the front (or lower) end of the 4th log so that it sits on the edge of the front burner as shown in Figure 80.
13. Place the 5th log (Figure 60) so that the bottom end of the log rests against the right wall panel and right base piece. Position the top end so that the longer branch is cradled in the crook of the 4th log (Figure 81).
14. Place the 6th log (Figure 61) so that the top end rests on top of the 2nd log and the bottom end rests against the left wall panel and left base piece (Figure 82). The bottom end should be close to the front edge of the left base piece but not so close that it will be disturbed when re-installing the fireplace door.
15. Left over ember pieces can be used to hide the edges of the base pieces in addition to placing some on top of the base pieces if desired.
16. Spread contents of bag of Ember Wool (Figure 63) in front of the logs to finish (Figure 82) .

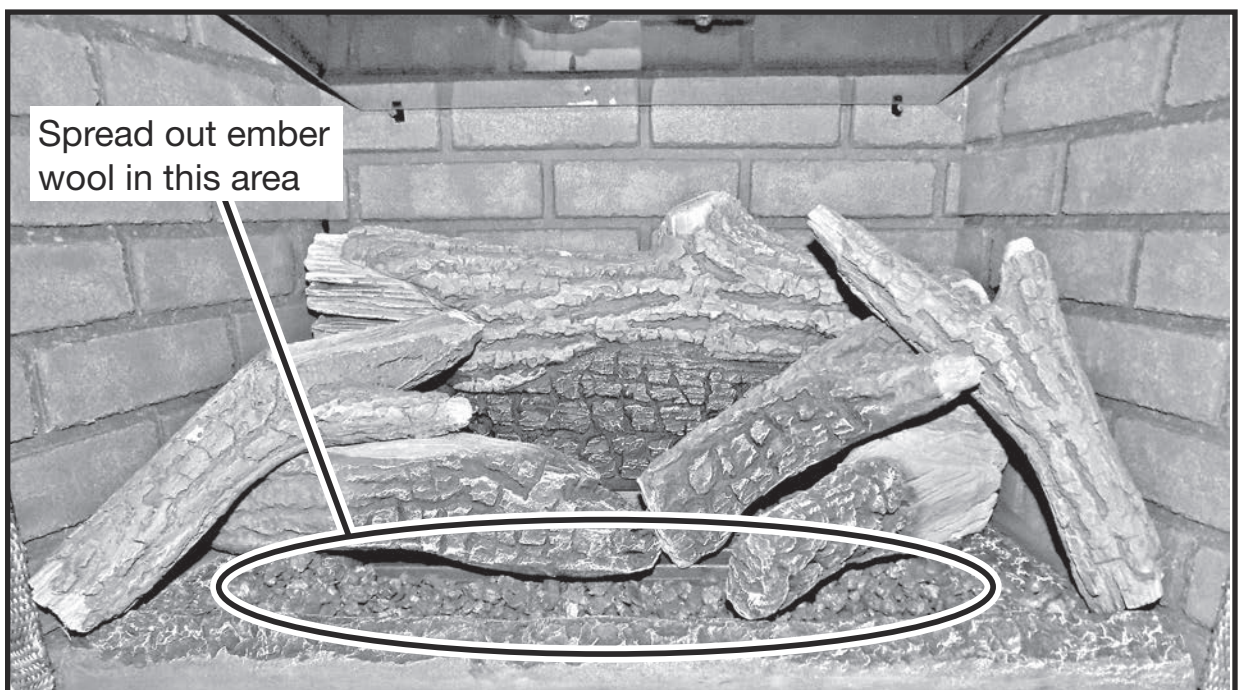

Figure 82: 6th log placement and ember wool distribution.

Driftwood Log Set Installation

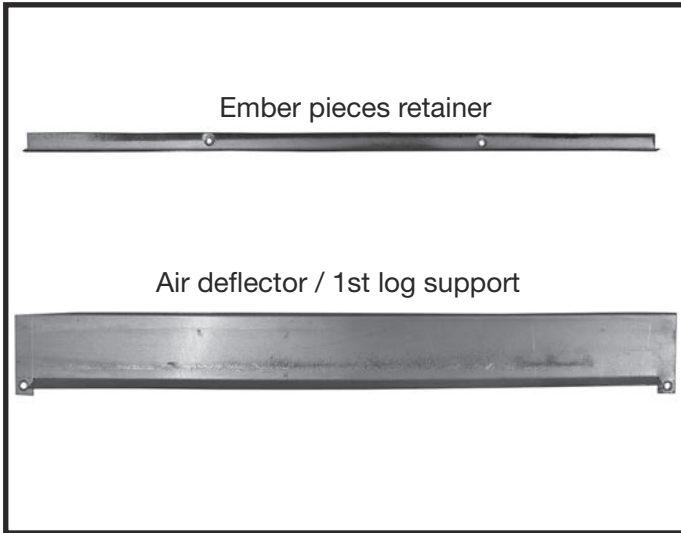

Figure 83: Ember pieces retainer and air deflector-1st log support.

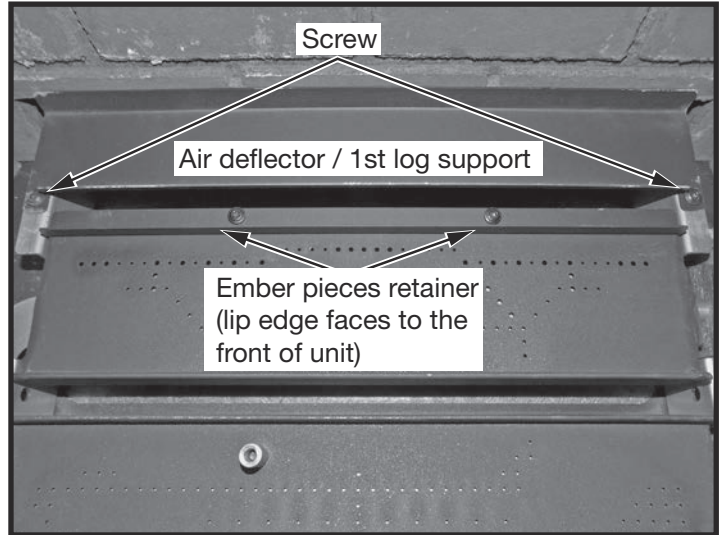

Figure 84: Gap between air deflector and burner.

Log set Installation

Note: Panel set must be installed before the Traditional log set installation begins.

1. Begin by placing the air deflector / 1st log support (Figure 83) behind the rear burner and up against the rear wall (Figure 84). Position so that the lip faces toward the front of the fireplace. Fasten the deflector down with supplied screws. Once the deflector is secured, there should be a gap of approximately 1/2 inch between the deflector and the front burner. This gap is required for air flow. Also secure the Ember pieces Retainer (Figure 83) along the back of the rear burner. This will help to keep the ember pieces from spilling over from the burner and down into the air gap.
2. Use 2 screws to secure the front mesh guard (Figure 85) along the leading edge of the front burner. The gap on the right side of the guard will fit around the pilot assembly as shown in Figure 86.

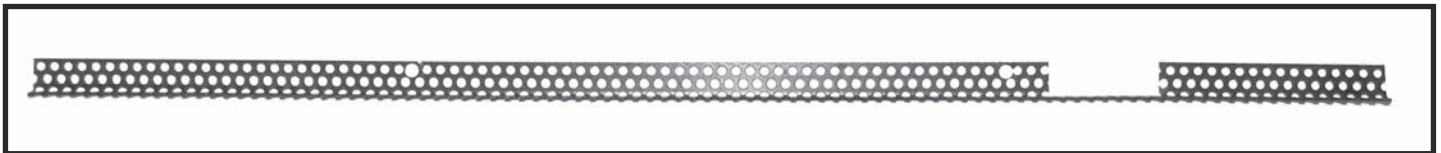

Figure 85: Front mesh guard.

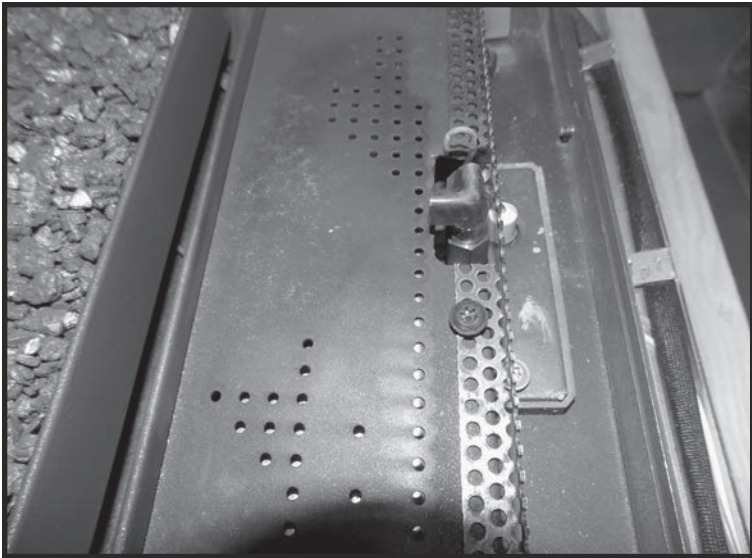

Figure 86: Front mesh guard in place.

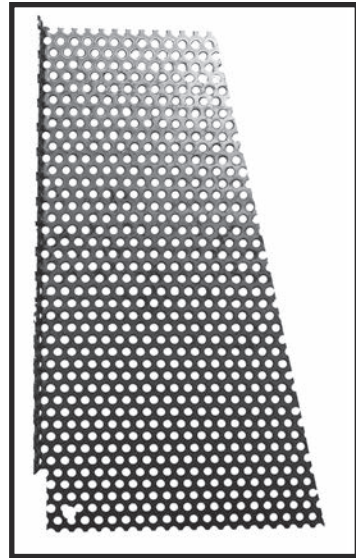

Figure 87: Side mesh guard.

- Place and secure with a single screw, the side mesh guard (Figure 87) on the right hand side of the firebox as shown in Figure 88.

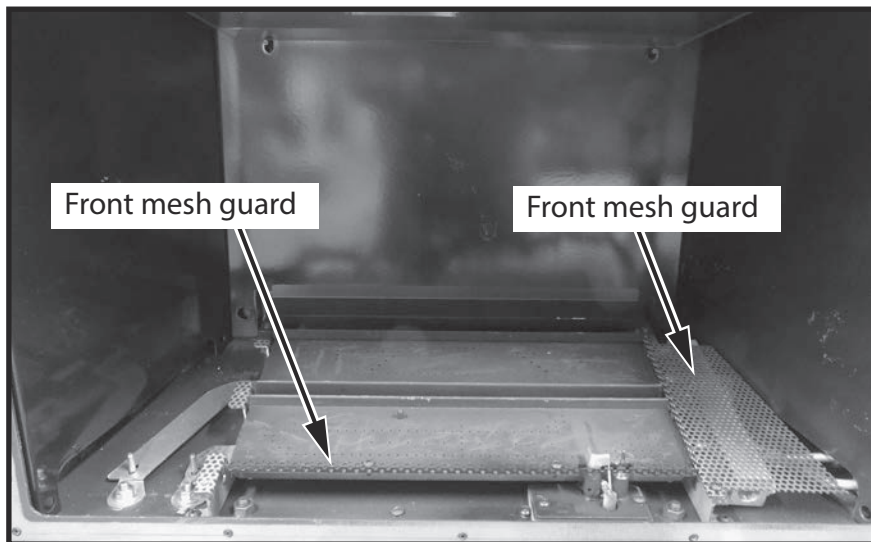

Figure 88: Front and side mesh guards in place.

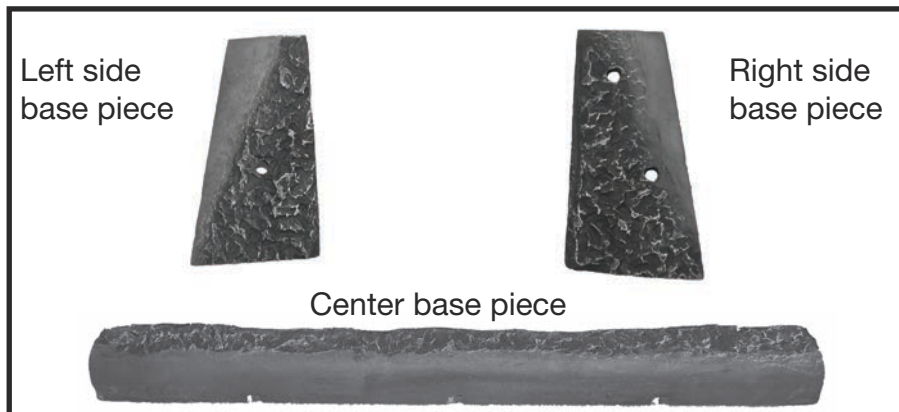

Figure 89: Log set base pieces.

4. Position the base pieces (Figure 89) as follows: Place the left and right base pieces so that their leading edges are parallel to the leading edge of the front burner (Figure 90). Follow this by placing the center base piece so that it covers the pilot assembly. Move all 3 pieces so that the front and side pieces are touching each other (Figure 91). These pieces will form containments for the ember material.

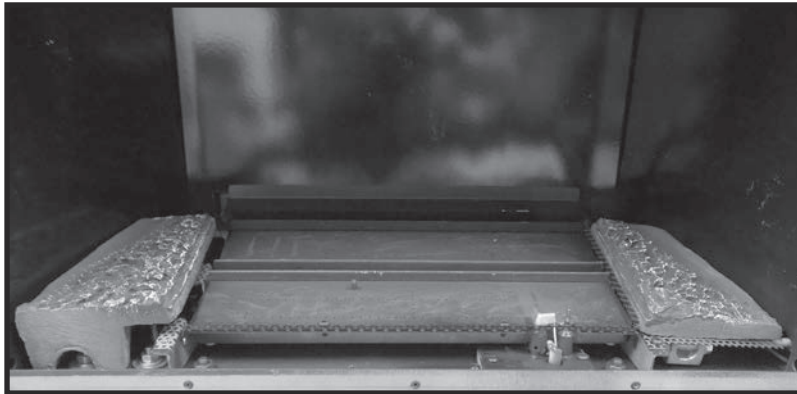

Figure 90: Left and right base pieces in place.

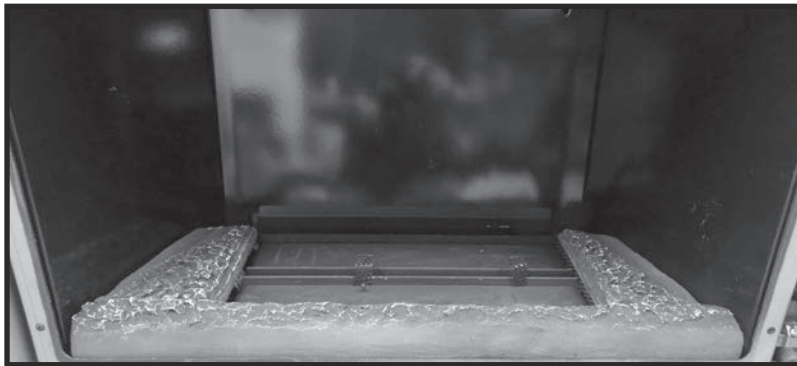

Figure 91: Front base piece in place.

5. Straddle the 2 2nd log supports between the rear of the front burner and the leading edge of the rear burner. Position them as shown in Figure 92.

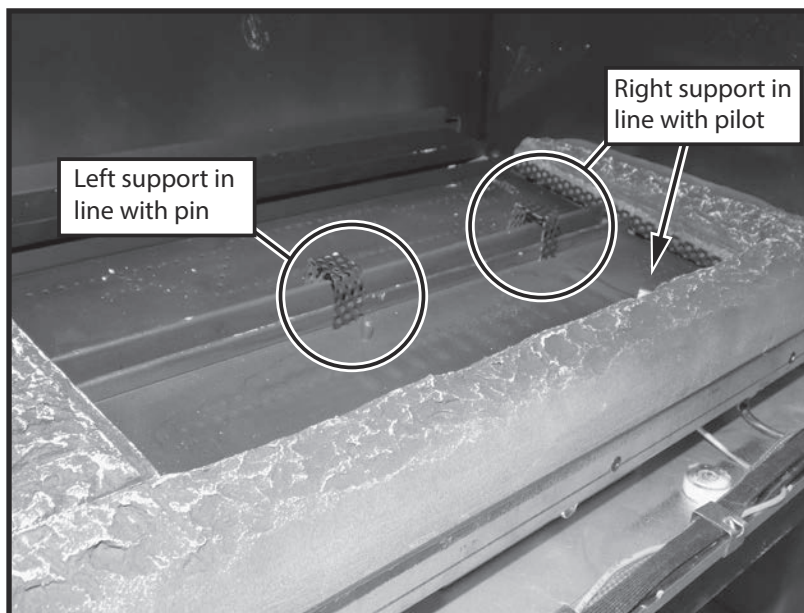

Figure 92: Supports for 2nd log.

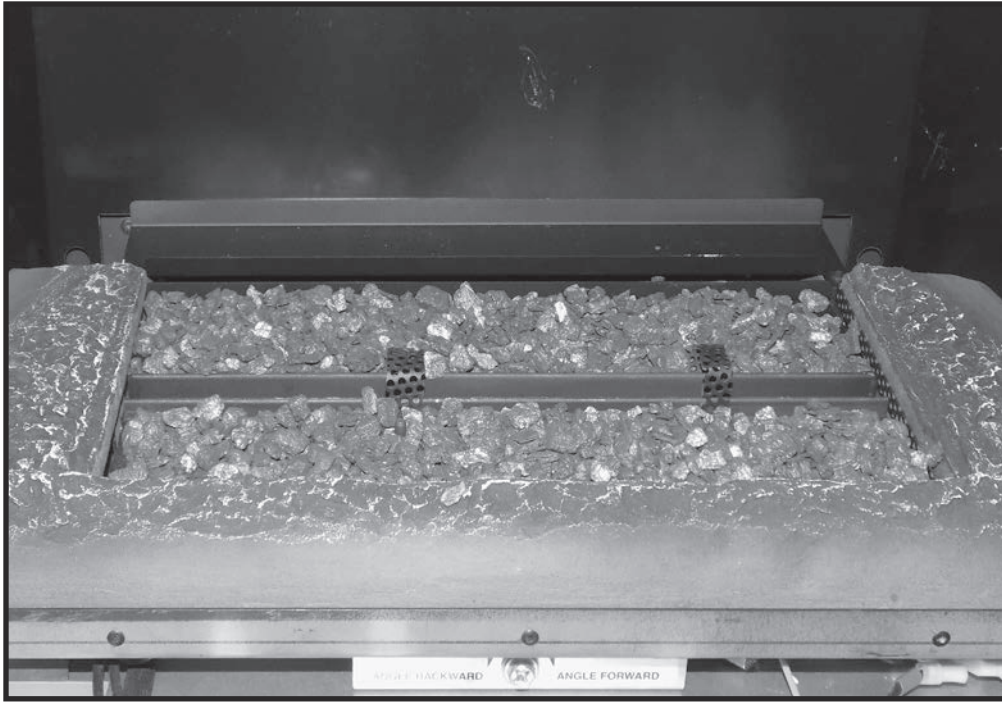

Figure 93: Ember pieces in burner tray.

6. Fill the burner trays with enough ember material to cover the bottom of the burner trays (Figure 93).
7. Locate the Driftwood log set (Figure 94) and install as follows:

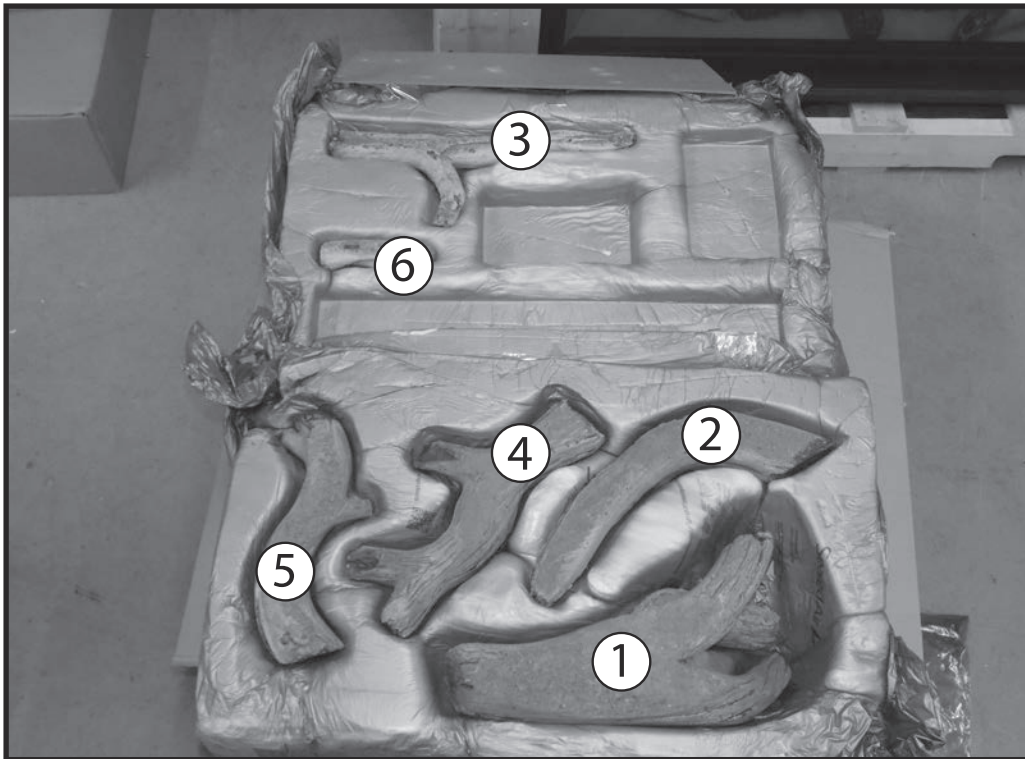

Figure 94: Driftwood log set.

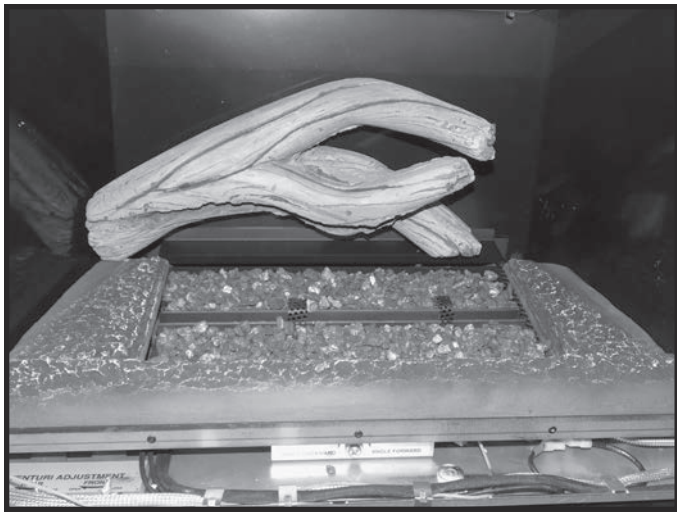

Figure 95: 1st log placement.



Figure 96: 2nd log placement.

8. Place the 1st log on top of the air deflector / 1st log support tray (Figure 83) so that is up against the rear wall (Figure 95). The left hand side of the log should be tucked into the left rear corner of the firebox.
9. Place the 2nd log so that it lays on top of the two log supports previously installed. The right hand end of the log should be making contact with the right hand firebox corner (Figure 96).
10. Lay the 3rd log (Figure 97) so that it rests on top of the rear edge of the center base piece. Its long branch should cover the seam where the center base piece and right hand base piece meet. The right hand tip of the log should just touch the right hand wall. The top branch should rest against the 2nd log.
11. The 4th log lays on top of the left base piece and also on the 1st log as shown in Figure 98. Its foremost branch is very close to where the glass door is but is not touching the left wall. The leftmost branch touches the left wall.



Figure 97: 3rd log placement.



Figure 98: Fourth log placement.



Figure 99: Fifth log placement.



Figure 100: Sixth log placement.

12. Place the 5th log on top of both the 2nd and 3rd log and up against the right hand wall (Figure 99).
13. Finish log set installation by placing the 6th log so that one end lays on the left base piece and the other end lays on top of the 3rd log piece.



Figure 101: Completed log set installation.

Manual Switch Installation for SIT Units

The manual ON/OFF switch for the fireplace comes semi-installed (Figure 103). All that is needed is to install the switch itself to the surround backing plate.

To install ON/OFF Switch

1. Check that the ON/OFF Switch cable is plugged into the SIT module (jack X8) as shown in Figure 102.

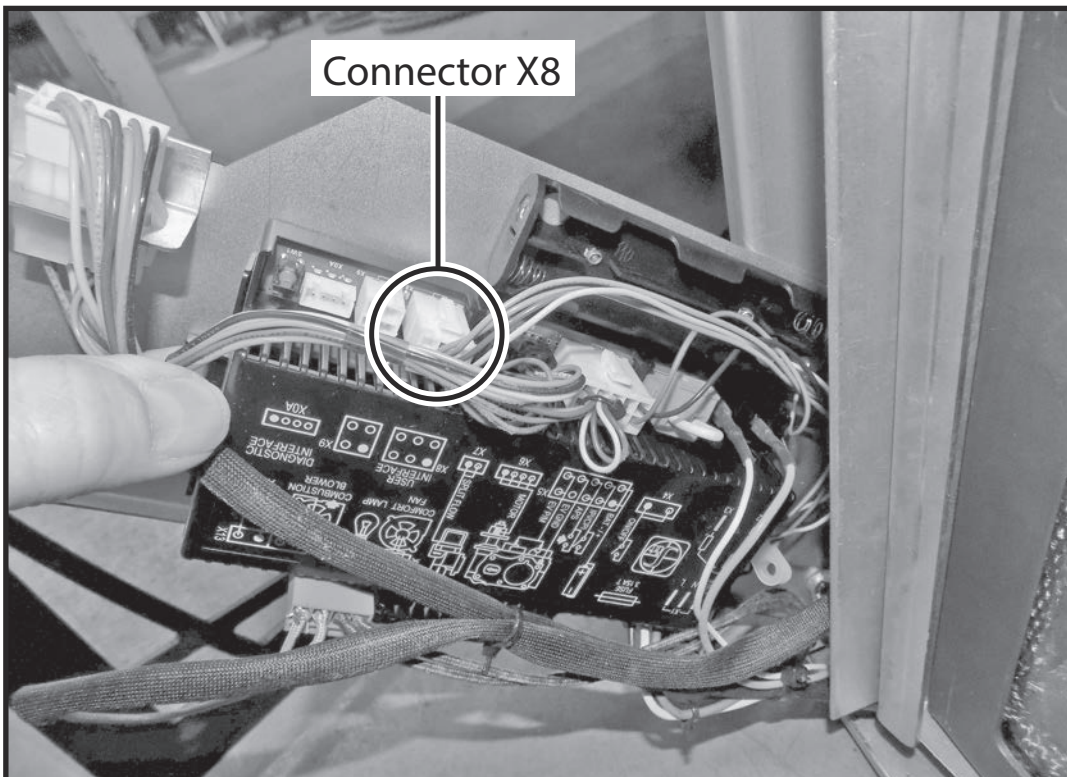

Figure 102: SIT manual switch connection at SIT module.

2. With the surround backing plate positioned in front of the fireplace, position the switch in behind the open slot in the backing plate and screw into place (Figure 104).
3. Install the surround backing plate and surround.

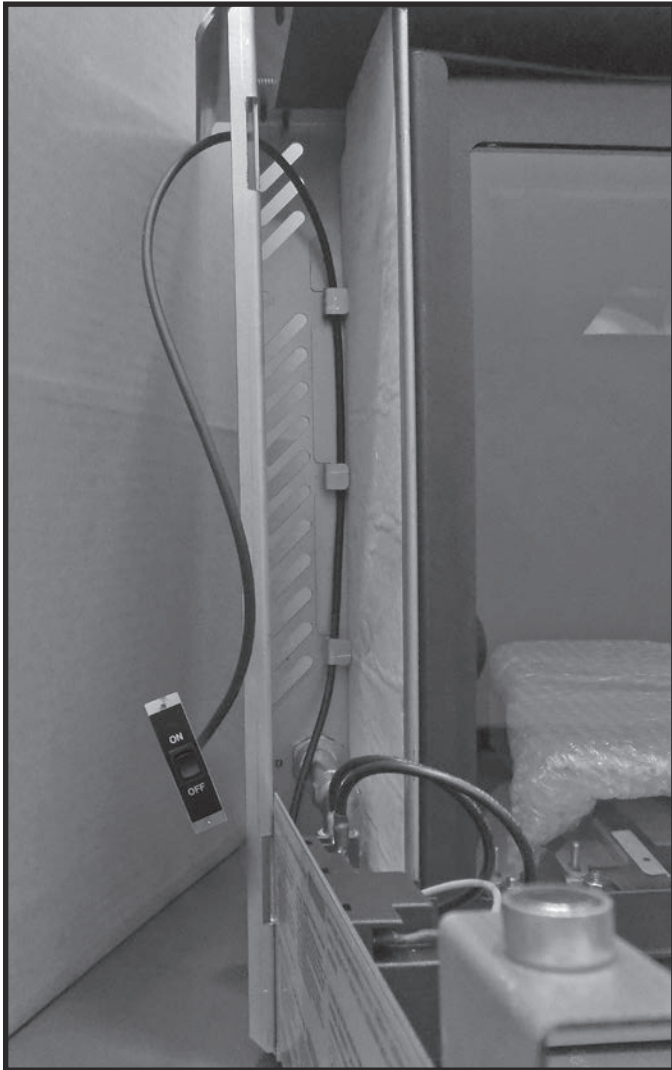

Figure 103: Pre-installed ON OFF switch SIT assembly.

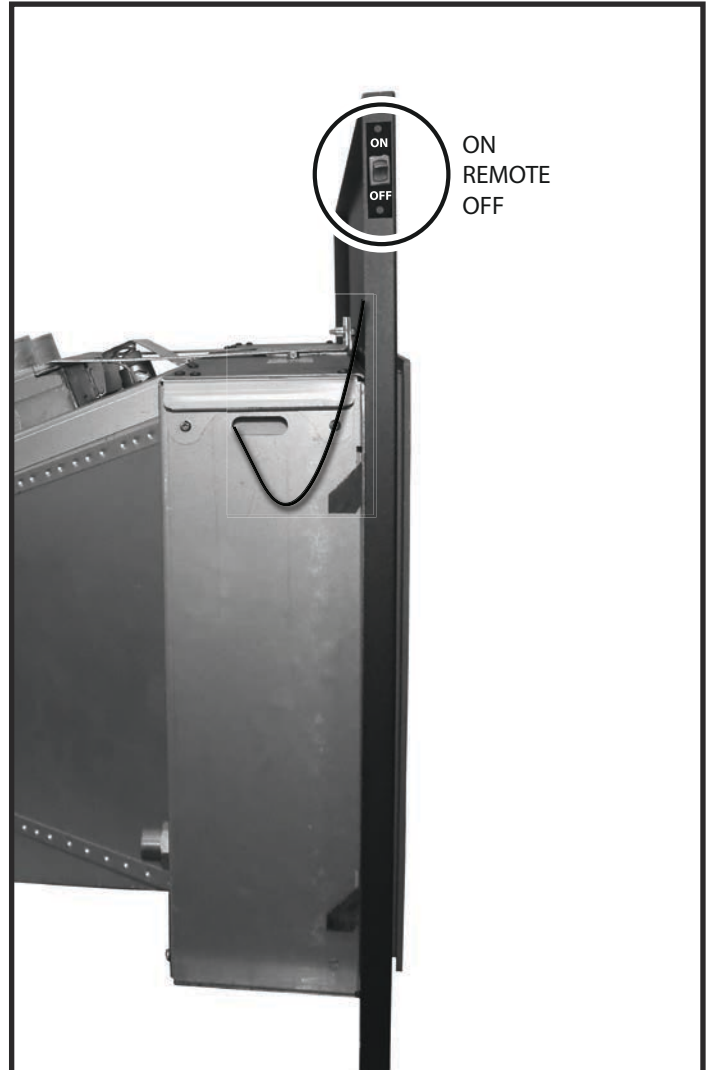

Figure 104: On Off switch for SIT units.

Manual Switch Installation for Maxitrol Units

The manual ON/OFF switch for the fireplace comes semi-installed. All that is needed is to install the switch itself to the surround backing plate.



Figure 105: Pre-installed ON OFF switch assembly.

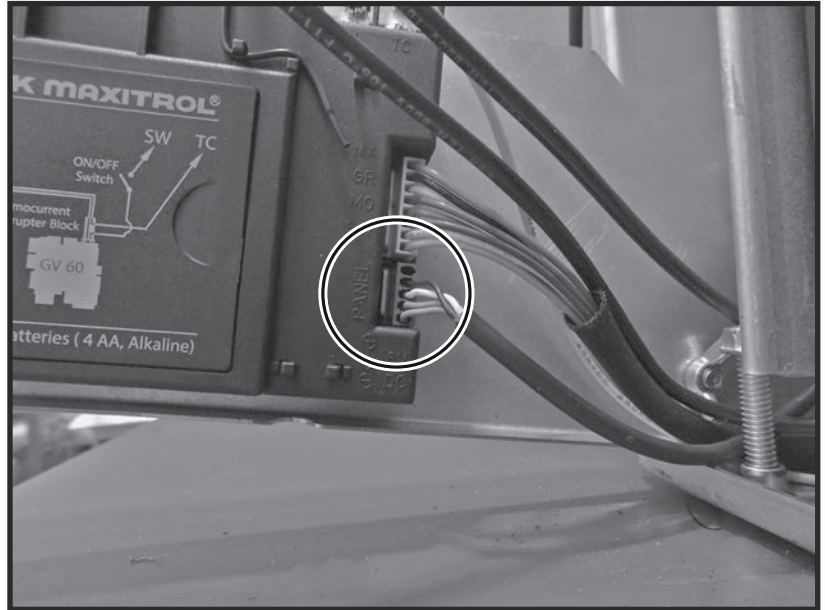

Figure 106: Switch connector at control module.

To install ON/OFF Switch

1. Check that the ON/OFF Switch cable is plugged into the Maxitrol module as shown in Figure 106.



Figure 107: Positioning the switch behind the backing plate opening slot.

2. Position the ON/OFF switch against the open slot on the surround backing plate. Be sure to orient the switch as shown in Figure 107.



Figure 108: Attaching switch to backing plate.

3. Use a 2mm Allen key to fasten the switch to the backing plate.

4. Install the surround backing plate and surround (Figure 109).

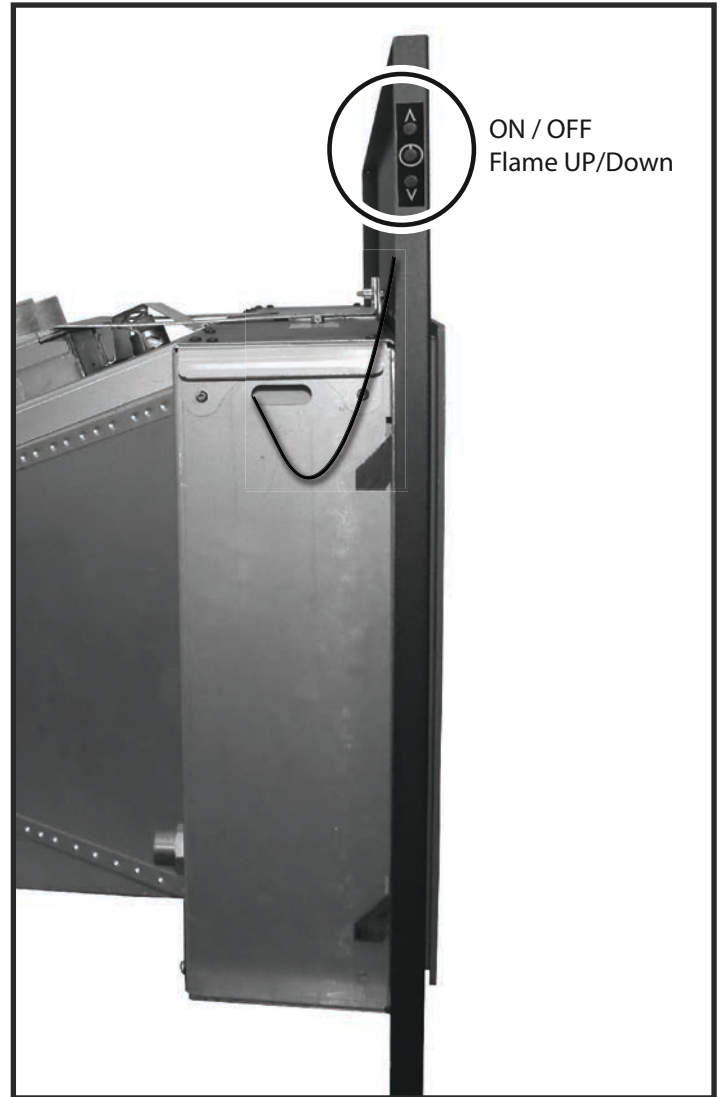

Figure 109: On Off switch location for Maxitrol units.

Pairing the SIT Remote Handset and Receiver

1. Install 4 AA batteries into the battery holder located behind the electronic control module on the pull - out caddy (Figure 110). Note: Batteries are not required if the fireplace is connected to an AC power source.
2. Install 3 AAA batteries into the SIT remote handset (Figure 111)
3. Plug the power cord into the Tofino and open the gas supply line.
4. With the decorative front and backing plate (Figure 116 and Figure 117) removed, press the button marked “PRG” on the caddy and press the program button once (Figure 112). The module will beep 3 times indicating that it is ready to synchronize with the remote handset.
5. On the remote handset, push the power on button once. The remote handset will beep 4 times to indicate that the remote handset and the control module are now synchronized. The remote handset is now ready to use.

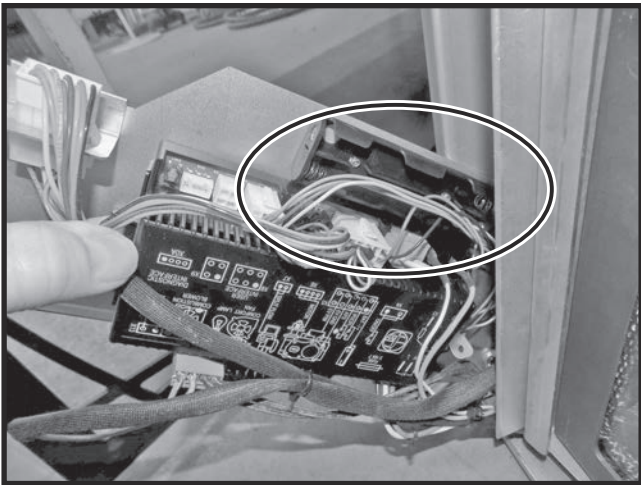

Figure 110: SIT module battery holder.



Figure 111: SIT remote handset and battery holder.

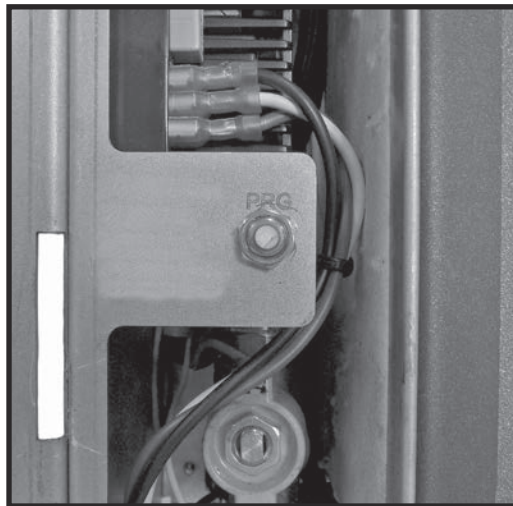

Figure 112: Program button.

Pairing the Maxitrol Remote Handset and Receiver

1. Insert batteries four double “AA” batteries into the receiver module (Figure 113).
2. Install 3 AAA batteries into the Maxitrol remote handset (Figure 114).
3. The receiver must learn the handset code: Remove the decorative front followed by the backing plate (Figure 116 and Figure 117). Locate the module caddy on the left-hand side of the fireplace. The reset button is located here (Figure 115).
4. Press and hold the receiver’s reset button (Figure 115) until you hear two (2) beeps. After the second, longer beep, release the reset button. Within the subsequent 20 seconds press the “ARROW DOWN” button on the handset until you hear two (2) short beeps confirming the code is set. The remote handset is now ready to use.

NOTE: This is a one time setting only, and it is not required when changing the batteries in the handset or receiver.

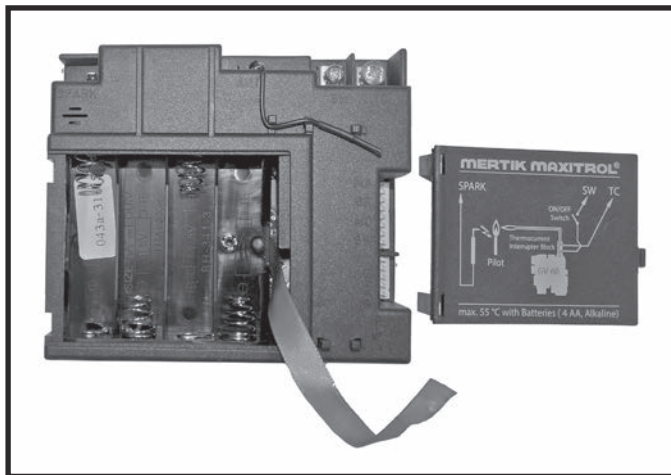

Figure 113: Maxitrol receiver module.



Figure 114: G6R remote.



Figure 115: Maxitrol reset button location.

Surround Installation/Removal Instructions

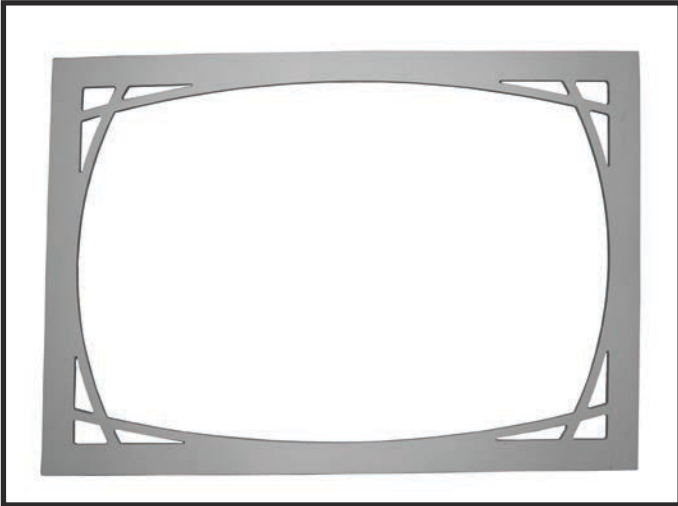

Figure 116: Decorative front.



Figure 117: Backing plate.

Installation

1. Attach the ON/OFF Switch face plate to the backing plate before seating the backing plate onto the fireplace.
2. Place the backing plate onto the fireplace by inserting its four hooks into the four slots on the fireplace frame (Figure 118).
3. Install the decorative front by inserting its four hooks into the corresponding slots on the backing plate (Figure 119).

Removal

Removal is the reverse of installation.

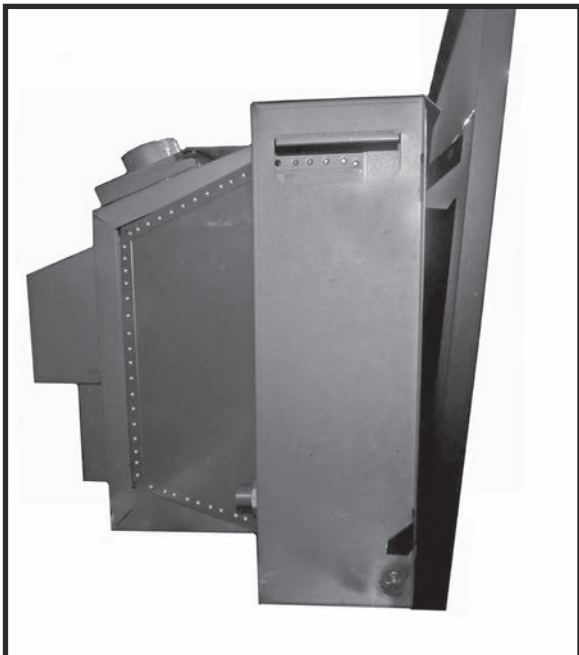

Figure 118: Mounting the backing plate.

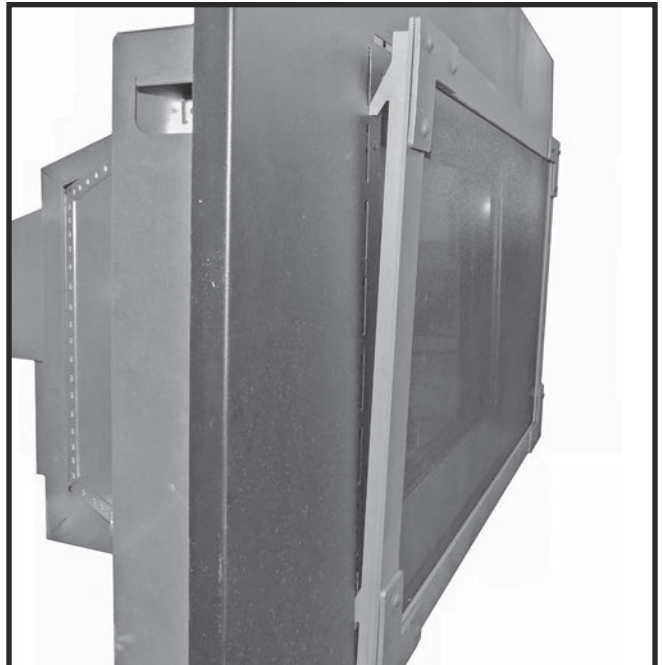

Figure 119: Mounting the decorative front.

Lighting Instructions

FOR YOUR SAFETY READ BEFORE LIGHTING

WARNING: If you do not follow these instructions exactly, a fire or explosion may result causing property damage, personal injury or loss of life.

A. This appliance is equipped with an ignition device which automatically lights the pilot. Do not try to light the pilot by hand.
 B. BEFORE LIGHTING smell all around the appliance area for gas. Be sure to smell next to the floor because some gas is heavier than air and will settle on the floor.

WHAT TO DO IF YOU SMELL GAS:

- Do not try to light any appliance.
- Do not touch any electric switch; do not use any phone in your building.

- Immediately call your gas supplier from a neighbour's phone. Follow the gas supplier's instructions.
- If you cannot reach your gas supplier, call the fire department.
- C. Use only your hand to push in or turn the gas control knob. Never use tools. If the knob will not push in or turn by hand, don't try to repair it, call a qualified service technician. Force or attempted repair may result in a fire or explosion.
- D. Do not use this appliance if any part has been under water. Immediately call a qualified service technician to inspect the appliance & to replace any part of the control system & any gas control which has been under water.

LIGHTING INSTRUCTIONS

1. STOP! Read the safety information above on this label.
2. This appliance is equipped with an ignition device which automatically lights the pilot. Do not try to light the pilot by hand.
3. Push the "On/Off" switch to turn the fireplace ON.
 - If the burner does light go to step 6.
 - If the burner does not light, complete steps 4 through 5.
 - If the burner will not light or stay lit after several tries, push the "On/Off" switch for the fireplace to OFF, turn off all electric power

- to the fireplace and call your service technician or gas supplier.
- Note: Sufficient time must be allowed for air to escape from lines if the unit is being lit for the first time.
- 4. Push the "On/Off" switch to the fireplace Off.
- 5. Allow sufficient length of time (minimum 5 minutes) for any gas in the combustion chamber to escape. If you still smell gas, STOP! Follow "B" in the safety information above on this label. If you don't smell gas, go to step 3.
- 6. Set fireplace to desired setting by using hand held remote.

TO TURN OFF GAS APPLIANCE

1. Push the "on/off" switch to the "Off" position.
2. Turn off all electric power to the appliance and remove backup batteries if service is to be performed or for extended shutdown.

Due to high surface temperatures, keep children, clothing and furniture away. Keep burner and control compartment clean. See installation and operating instructions accompanying the appliance.

A cause de la temperature elevee des parois, tenir eloignes les enfants, les vetements et les meubles. Maintenir propres le brûleur et le compartiment de commande. Voir les instructions relatives a l'installation et au fonctionnement qui accompagnent l'appareil.

CAUTION: Hot while in operation. Do not touch. Severe burns may result. Keep children, clothing, furniture, gasoline and other liquids having flammable vapours away. Keep burner and control compartment clean. See installation and operating instructions accompanying the appliance.

ATTENTION L'appareil est chaud lorsqu'il fonctionne. Ne pas toucher l'appareil. Risque de brûlures graves. Surveiller les enfants. Garder les vêtements, le meubles, l'essence ou autres liquides produisant des vapeurs inflammables loin de l'appareil. S'assurer que le brûleur et le compartiment des commandes sont propres. Voir les instructions d'installation et d'utilisation qui accompagnent l'appareil.

5052.980-A

The lighting instructions label is located on the back of the gas valve controller caddy (Figure 120). It is accessed by removing the surround and then pulling the caddy out to reveal the lighting instruction label.



Figure 120: Lighting instructions label location.

Maintenance

CAUTION:

Turn off gas and electrical power supply (if applicable) and allow ample time for unit to cool before servicing appliance. It is recommended that the fireplace and its venting should be inspected at least once a year by a qualified service person.

Glass Door:

Warning: Do not operate fireplace with glass door removed, cracked or broken. Replacement of the glass door should be done by a licensed or qualified service person.

Do not strike or otherwise impact the glass in anyway that may cause it to break. If the glass becomes cracked or broken it must be replaced before using the fireplace. Replacement door can be obtained from your nearest Pacific Energy Fireplaces dealer. The size required is dependent on which version of Tofino is installed. Use original Tofino door only. Do not substitute with any other type.

To remove broken glass, remove door frame as noted in See "Door Installation/Removal" on page 15.

Install the new door onto the fireplace.

Annual Inspection:

- a) Remove glass door and inspect if soot buildup is present. Inspect the burner assembly and the ceramic glass baffle for soot buildup. If excessive buildup of soot is present, have a qualified service person inspect and adjust unit for proper combustion. Clean logs and burner with a brush or vacuum cleaner, paying close attention to burner ports.
- b) Check the pilot system for proper flame size and operation. Clean pilot free of soot, dust or any other deposits (Figure 121 and Figure 122). Have a qualified service person adjust the pilot flame.
- c) Check that the vent pipe and vent terminal are open and free from blockage or debris. If the venting is disassembled for cleaning, it must be properly assembled and re-sealed. See Venting section in Installation manual proper procedure.
- d) Check glass panel gasket, replace the door if necessary. It is important that the glass seal be maintained in good condition.
- e) Check and replace batteries as needed.

Note: The appliance area must be kept clear and free from combustible materials, gasoline and other flammable vapours and liquids.

Periodically:

- a) Viewing glass may be cleaned as necessary with fireplace glass cleaner.
- b) Exterior finish may be cleaned with mild soap and water.

CAUTION:

Do not use abrasive cleaners on glass or any other part of the fireplace. Do not clean glass when hot.

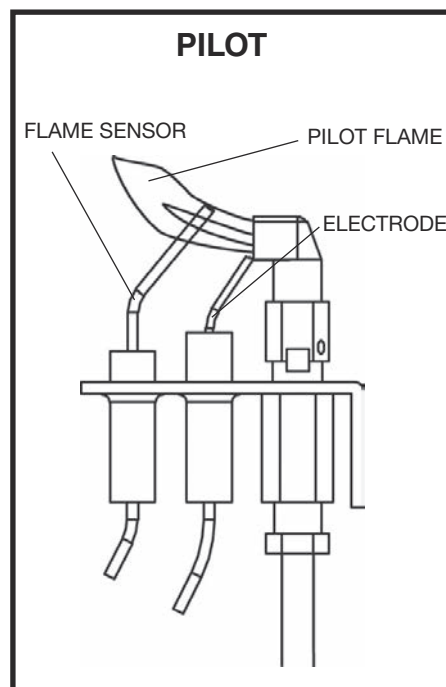

Figure 121: SIT pilot assembly.

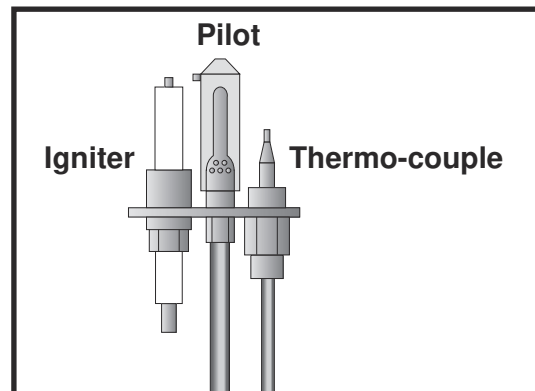
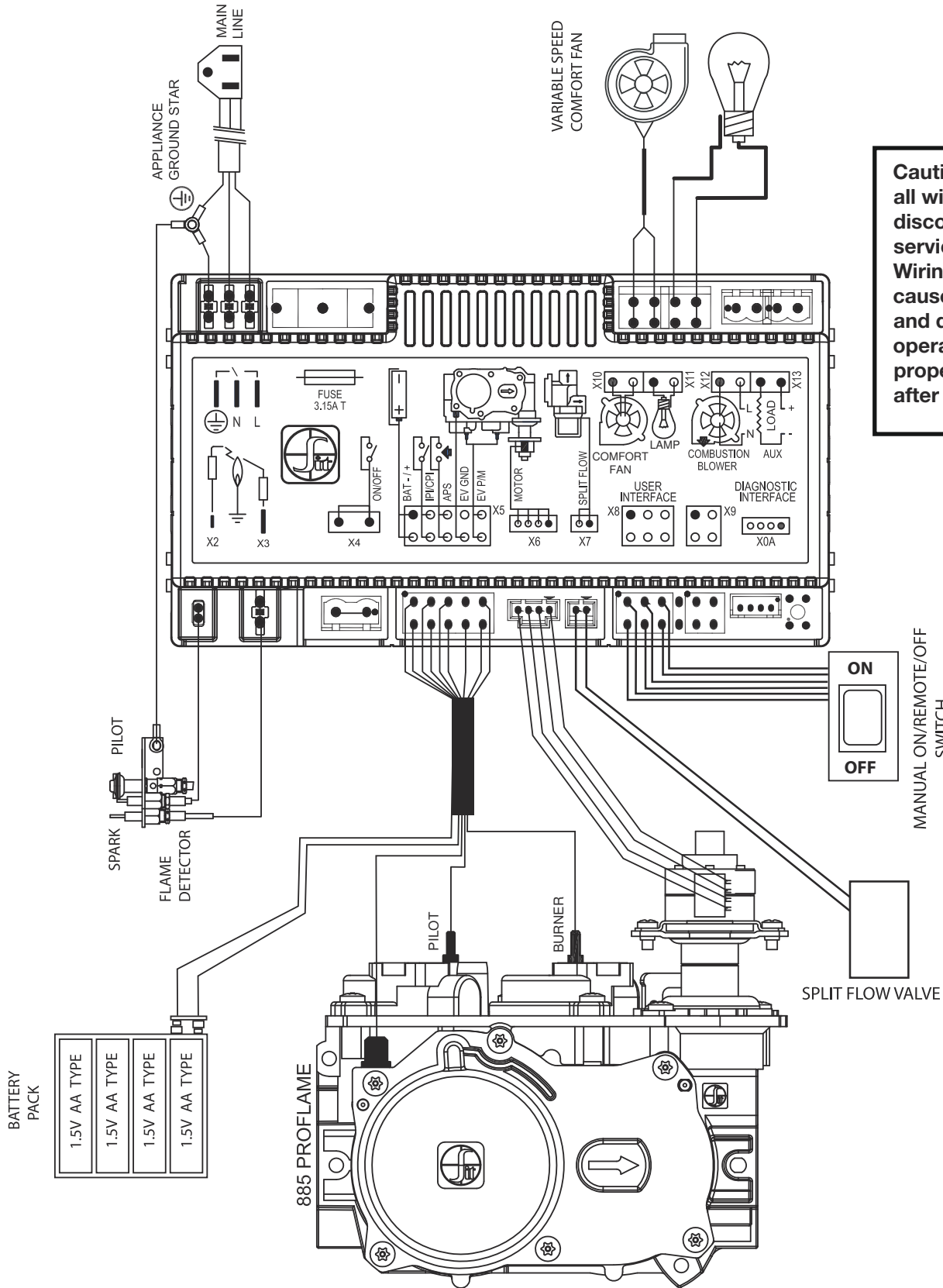

Figure 122: Maxitrol pilot.

Wiring Diagram for SIT Proflame



Caution: Label all wires prior to disconnection when servicing controls. Wiring errors can cause improper and dangerous operation. Verify proper operation after servicing.

Wiring Diagram for Maxitrol

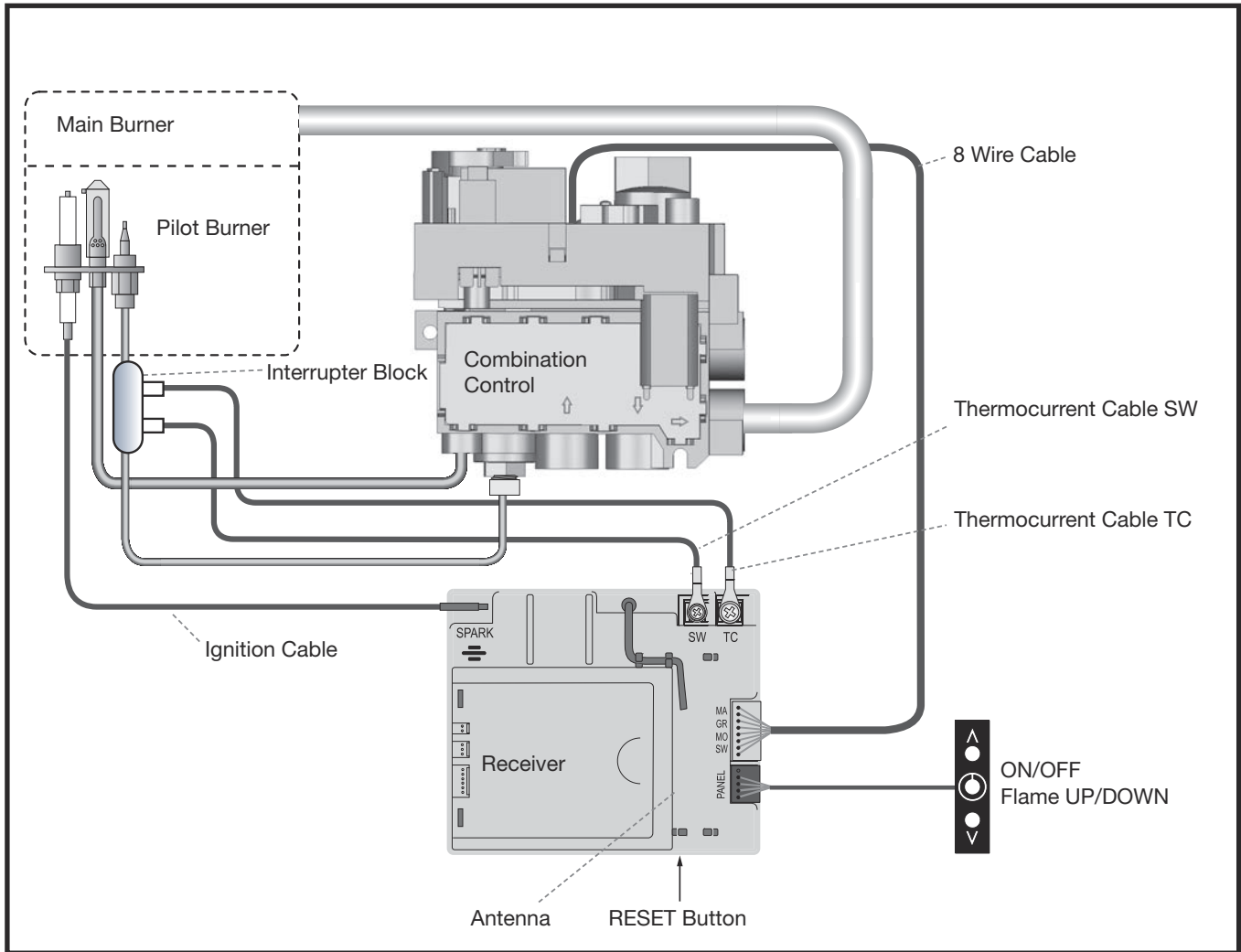

Figure 123: Maxitrol wiring diagram.

Tofino i20 Rating Label

SIT Version

WARNING: Improper installation, adjustment, alteration, service or maintenance can cause injury or property damage. Refer to the owner's information manual provided with this appliance. For assistance or additional information, consult a qualified installer, service agency or the gas supplier. **AVERTISSEMENT:** Une installation, un réglage, une modification, une réparation ou un entretien mal effectué peut causer des dommages matériels ou des blessures. Voir la notice de l'utilisateur qui accompagne l'appareil. Pour de l'aide ou des renseignements supplémentaires, consultez un installateur, un technicien agréé ou le fournisseur de gaz.

This appliance equipped for altitudes 0 - 4500 ft. (0 - 1372 m) / Cet unité est conçu pour des altitudes variant entre 0 - 4500 pieds (0 - 1372 m). In Canada, also certified for installation in a bedroom or a bed sitting room / Aussi certifié pour installation dans une chambre à coucher ou une salle de séjour. This appliance must be installed in accordance with local codes, if any; if none, follow the current CAN/CGA-B149 (Canada), or ANSI Z223.1 (USA) Installation Codes. Installer l'appareil selon les codes ou règlements locaux, ou, en l'absence de tels règlements, selon les codes d'installation CAN/CGA-B149 (Canada), or ANSI Z223.1 (USA) en vigueur.



MODEL / MODELE:
TOFINO i20s
SERIES/ SERIE: **A**



MADE IN CANADA
FABRIQUE AU CANADA

5050.920-A Tofino i20s 041016

VENTED GAS FIREPLACE - NOT FOR USE WITH SOLID FUEL

FOYER AU GAZ À ÉVACUATION - NE PAS UTILISER AVEC DU COMBUSTIBLE SOLIDE

ANSI Z21.88-2014 / CSA 2.23-2014 Vented Gas Fireplaces/Heaters. CAN/CGA 2.17-M91 Gas-Fired Appliance For Use At High Altitudes.

Certified for / Certifié pour Canada and U.S.A.

FOR USE WITH/ EN CASE D'EMPLOI AVEC:

Minimum supply pressure / Pression minimum d'alimentation:
(For the purpose of input adjustment / dans le but de régler l'alimentation)
Maximum supply pressure / Pression maximum d'alimentation:
Manifold pressure / Pression de la tuyauterie: Maximum

Orifice Size / Diametre de l'injecteur:

Input BTU/hr (kW) / Entree BTU/h (kW):

215

This Appliance is Equipped For Use With / Cet Appareil est Équipé Pour Utiliser Avec :

NATURAL GAS GAZ NATUREL	LP-GAS LP GAZ
5.0 in/wc / 5.0 po/c.e. (1.25 kPa)	12.5 in/wc / 12.5 po/c.e. (3.11 kPa)
13.9 in/wc / 13.9 po/c.e. (3.45 kPa)	13.9 in/wc / 13.9 po/c.e. (3.45 kPa)
3.5 in/wc / 3.5 po/c.e. (0.95 kPa)	10.0 in/wc / 10.0 po/c.e. (2.74 kPa)
Front: AA, Rear: BA	Front: CA, Rear: DA
Max. 20,000 (5.86) Min. 6,000 (1.76)	Max. 20,000 (5.86) Min. 7,000 (2.05)

Electrical Rating: 115VAC, 60Hz, 0.7A / Normes Électriques: 115VAC, 60Hz, 0.7A

MANUFACTURED (MOBILE) HOME: This appliance is only for use with the type of gas indicated on the rating plate and may be installed in an aftermarket, permanently located, manufactured (mobile) home where not prohibited by local codes. See owners manual for details.

FABRIQUEZ (MOBILE) MAISON: Cet appareil doit être utilisé uniquement avec le type de gaz indiqué sur la plaque signalétique et peut être installé dans une maison préfabriquée (mobile) installée à demeure si les règlements locaux le permettent. Voir la notice du propriétaire pour plus de détails. Cet appareil ne peut être converti à d'autres gaz sauf si une trousse de conversion certifiée est utilisée. Install in accordance with the current standard Mobile Homes, CAN/CSA Z240 MH (in CANADA), and the Manufacturer's Home Construction and Safety Standard, Title 24 CFR, Part 3280, or the current Standard for Fire Safety Criteria for Manufactured Home Installations, Sites, and Communities ANSI/NFPA 501A, (in the U.S.A.). Cet appareil doit être installé conformément aux exigences de la norme CAN/CSA Z240 MH en vigueur de l'ACNOR, Installations de gaz dans les Constructions Mobiles.

FOR USE WITH THE GLASS AND SCREEN BARRIER CERTIFIED WITH THE APPLIANCE ONLY / POUR UTILISATION UNIQUEMENT AVEC LES PORTES EN VERRE CERTIFIÉES AVEC L'APPAREIL

Clearance to combustibles

Bottom of appliance to 14" mantel:	30"
Center of appliance to side wall:	18"
Hearth in front of appliance:	0"
Under appliance:	0"
Objects in front of appliance:	36"

Maxitrol Version

WARNING: Improper installation, adjustment, alteration, service or maintenance can cause injury or property damage. Refer to the owner's information manual provided with this appliance. For assistance or additional information, consult a qualified installer, service agency or the gas supplier. **AVERTISSEMENT:** Une installation, un réglage, une modification, une réparation ou un entretien mal effectué peut causer des dommages matériels ou des blessures. Voir la notice de l'utilisateur qui accompagne l'appareil. Pour de l'aide ou des renseignements supplémentaires, consultez un installateur, un technicien agréé ou le fournisseur de gaz.

This appliance equipped for altitudes 0 - 4500 ft. (0 - 1372 m) / Cet unité est conçu pour des altitudes variant entre 0 - 4500 pieds (0 - 1372 m). In Canada, also certified for installation in a bedroom or a bed sitting room / Aussi certifié pour installation dans une chambre à coucher ou une salle de séjour. This appliance must be installed in accordance with local codes, if any; if none, follow the current CAN/CGA-B149 (Canada), or ANSI Z223.1 (USA) Installation Codes. Installer l'appareil selon les codes ou règlements locaux, ou, en l'absence de tels règlements, selon les codes d'installation CAN/CGA-B149 (Canada), or ANSI Z223.1 (USA) en vigueur.



MODEL / MODELE:
TOFINO i20m
SERIES/ SERIE: **A**



MADE IN CANADA
FABRIQUE AU CANADA

5050.925-A Tofino i20m 041016

VENTED GAS FIREPLACE - NOT FOR USE WITH SOLID FUEL

FOYER AU GAZ À ÉVACUATION - NE PAS UTILISER AVEC DU COMBUSTIBLE SOLIDE

ANSI Z21.88-2014 / CSA 2.23-2014 Vented Gas Fireplaces/Heaters. CAN/CGA 2.17-M91 Gas-Fired Appliance For Use At High Altitudes.

Certified for / Certifié pour Canada and U.S.A.

FOR USE WITH/ EN CASE D'EMPLOI AVEC:

Minimum supply pressure / Pression minimum d'alimentation:
(For the purpose of input adjustment / dans le but de régler l'alimentation)
Maximum supply pressure / Pression maximum d'alimentation:
Manifold pressure / Pression de la tuyauterie: Maximum

Orifice Size / Diametre de l'injecteur:

Input BTU/hr (kW) / Entree BTU/h (kW):

216

This Appliance is Equipped For Use With / Cet Appareil est Équipé Pour Utiliser Avec :

NATURAL GAS GAZ NATUREL	LP-GAS LP GAZ
5.0 in/wc / 5.0 po/c.e. (1.25 kPa)	12.5 in/wc / 12.5 po/c.e. (3.11 kPa)
13.9 in/wc / 13.9 po/c.e. (3.45 kPa)	13.9 in/wc / 13.9 po/c.e. (3.45 kPa)
3.8 in/wc / 3.8 po/c.e. (0.95 kPa)	10.0 in/wc / 10.0 po/c.e. (2.74 kPa)
Front: AA, Rear: BA	Front: CA, Rear: DA
Max. 20,000 (5.86) Min. 10,000 (2.93)	Max. 20,000 (5.86) Min. 10,000 (2.93)

MANUFACTURED (MOBILE) HOME: This appliance is only for use with the type of gas indicated on the rating plate and may be installed in an aftermarket, permanently located, manufactured (mobile) home where not prohibited by local codes. See owners manual for details.

FABRIQUEZ (MOBILE) MAISON: Cet appareil doit être utilisé uniquement avec le type de gaz indiqué sur la plaque signalétique et peut être installé dans une maison préfabriquée (mobile) installée à demeure si les règlements locaux le permettent. Voir la notice du propriétaire pour plus de détails. Cet appareil ne peut être converti à d'autres gaz sauf si une trousse de conversion certifiée est utilisée. Install in accordance with the current standard Mobile Homes, CAN/CSA Z240 MH (in CANADA), and the Manufacturer's Home Construction and Safety Standard, Title 24 CFR, Part 3280, or the current Standard for Fire Safety Criteria for Manufactured Home Installations, Sites, and Communities ANSI/NFPA 501A, (in the U.S.A.). Cet appareil doit être installé conformément aux exigences de la norme CAN/CSA Z240 MH en vigueur de l'ACNOR, Installations de gaz dans les Constructions Mobiles.

FOR USE WITH THE GLASS AND SCREEN BARRIER CERTIFIED WITH THE APPLIANCE ONLY / POUR UTILISATION UNIQUEMENT AVEC LES PORTES EN VERRE CERTIFIÉES AVEC L'APPAREIL

Clearance to combustibles

Bottom of appliance to 14" mantel:	30"
Center of appliance to side wall:	18"
Hearth in front of appliance:	0"
Under appliance:	0"
Objects in front of appliance:	36"



i20 TOFINO

50

100118-52 10000328

Rating label location

The rating label for the Tofino is located on the left-hand outside wall of the insert.



Figure 124: Rating label location.

© 2018 Copyright Pacific Energy Fireplace Products LTD.
Reproduction, adaptation, or translation
without prior written permission is prohibited
except as allowed under the copyright laws.



For technical support, please contact your retailer

**Web site: www.pacificenergy.net
2975 Allenby Rd., Duncan, BC V9L 6V8**